



## Thermal Management Solutions CONTENTS

Product Item	Part Number	Page
Multilayer NTC Thermistors	The NTC Thermistors	2
	ERT JZ ERT J0 ERT J1	3
	Handling Precautions	11
NTC Thermistors for automotive devices (chip type)	ERT J0 M ERT J1 M	16
	Handling Precautions	21
"PGS" Graphite Sheets SSM(Semi-Sealing Material)	EYG S EYG A EYG E	26
	Minimum order	32
	Handling Precautions	34
"NASBIS" Insulating Sheet	EYG Y EYG N	35
	Handling Precautions	38
"Graphite-PAD" high thermal conductivity in z-direction	EYG T	39
	Handling Precautions	42
"Soft-PGS (Compressible Type)" PGS with low thermal resistance	EYG S	43
	Handling Precautions	47

### All products in this catalog comply with the RoHS Directive.

The RoHS Directive is "the Directive (2011/65/EU) on the Restriction of the Use of Certain Hazardous Substances in Electrical and Electronic Equipment " and its revisions.

## The NTC Thermistors

NTC Thermistors is a negative temperature coefficient resistor that significantly reduces its resistance value as the heat/ ambient temperature rises. Thermistors is sintered in high-temperature (1200 °C to 1500 °C), and manufactured in various shapes. It's comprised of 2 to 4 kinds of metal oxides: iron, nickel, cobalt, manganese and copper.

### Features

- Temperature Coefficient of Resistance is negative, and it's extremely large (-2.8 to -5.1 [%/°C]).
- Various shapes, especially compact size components are available.
- Selection of resistance value is comparatively free, it's available from several tens Ω to several hundred kΩ.

### Recommended Applications

- For temperature measurement or temperature detection : Thermometer, temperature controller
- For temperature compensation : Transistor, transistor circuit, quartz oscillation circuit, and measuring instruments

### Physical Characteristics of NTC Thermistors

Thermistor is a resistor sensitive to temperature that is utilizing the characteristic of metal oxide semiconductor having large temperature coefficient. And its temperature dependency of resistance value is indicated by the following equation :

$$R=R_0 \exp \left[ B \left( \frac{1}{T} - \frac{1}{T_0} \right) \right] \dots\dots\dots(1)$$

$T_0$  : Standard Temperature 298.15 K(25 °C)  
 $R_0$  : Resistance at  $T_0$  [K]  
 $B$  : Thermistor Constant [K]

Temperature coefficient ( $\alpha$ ) in general meaning is indicated as follows :

$$\alpha = -\frac{B}{T^2} \dots\dots\dots(2)$$

Since the change by temperature is considerably large,  $\alpha$  is not appropriate as a constant. Therefore, B value (constant) is generally used as a coefficient of thermistors.

### Major Characteristics of NTC Thermistors

The relation between resistance and temperature of a thermistor is linear as shown in Fig. 2. The resistance value is shown in vertical direction in a logarithmic scale and reciprocal of absolute temperature (adding 273.15 to centigrade) is shown in horizontal direction.

The B value (constant) determines the gradient of these straight lines. The B value (constant) is calculated by using following equation.

$$B = \frac{\ln R_1 - \ln R_2}{\frac{1}{T_1} - \frac{1}{T_2}} \dots\dots\dots(3)$$

$R_1$ : Resistance at  $T_1$  K  
 $R_2$ : Resistance at  $T_2$  K

When you calculate this equation, you'll find that B value is not exactly constant. The resistance is expressed by the following equation :

$$R = AT^{-C} \exp D/T \dots\dots\dots(4)$$

In (4), C is a small positive or negative constant and quite negligible except for use in precision temperature-measuring device, therefore, the B value can be considered as constant number.

In Fig. 1, the relation between the resistance ratio  $R_T/R_{25}$  ( $R_{25}$ : Resistance at 25 °C,  $R_T$ : Resistance at T °C) and B Value is shown with T °C, in the horizontal direction.

Fig. 1

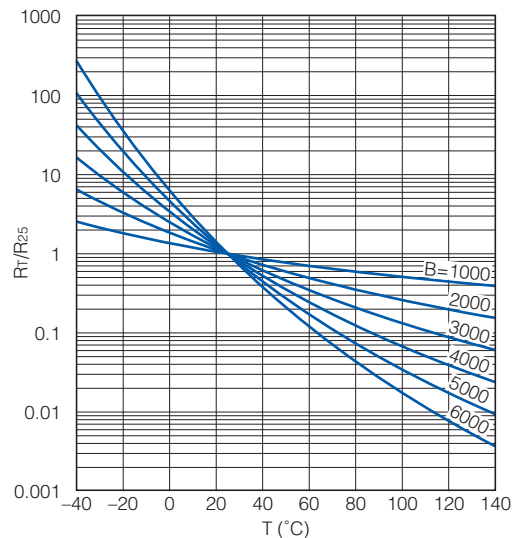
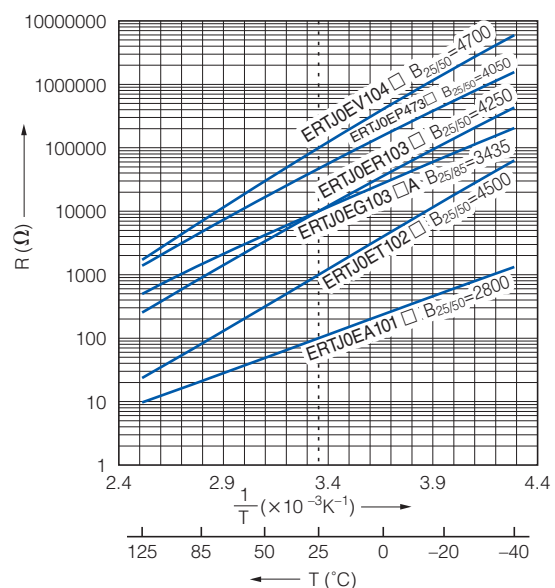

Fig. 2



Design and specifications are each subject to change without notice. Ask factory for the current technical specifications before purchase and/or use. Should a safety concern arise regarding this product, please be sure to contact us immediately.

## Multilayer NTC Thermistors

Series: **ERTJ**

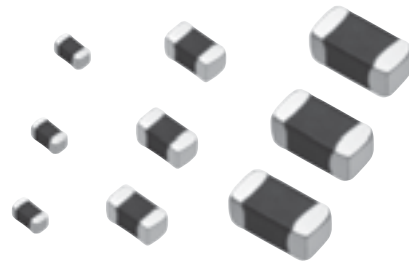

### Features

- Surface Mount Device (0201, 0402, 0603)
- Highly reliable multilayer / monolithic structure
- Wide temperature operating range (−40 to 125 °C)
- Environmentally-friendly lead-free
- RoHS compliant

### Recommended Applications

- Mobile Phone
  - Temperature compensation for crystal oscillator
  - Temperature compensation for semiconductor devices
- Personal Computer and Peripheral Device
  - Temperature detection for CPU and memory device
  - Temperature compensation for ink-viscosity (Inkjet Printer)
- Battery Pack (secondary battery)
  - Temperature detection of battery cells
- Liquid Crystal Display
  - Temperature compensation of display contrast
  - Temperature compensation of display backlighting (CCFL)

### Explanation of Part Numbers

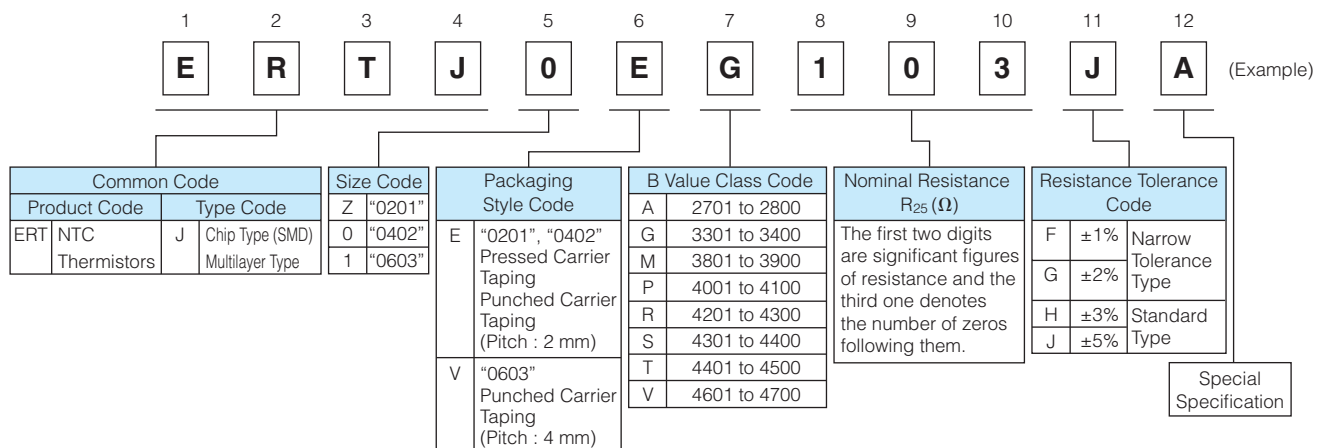

### Construction

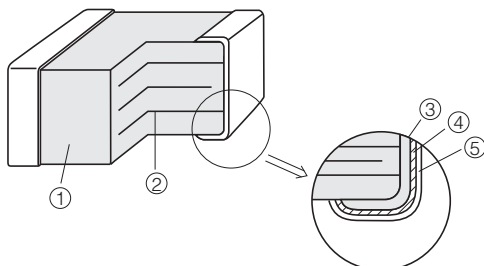

No.	Name	
①	Semiconductive Ceramics	
②	Internal electrode	
③	Terminal electrode	Substrate electrode
④		Intermediate electrode
⑤		External electrode

## Ratings

Size code (EIA)	Z(0201)	O(0402)	1(0603)
Operating Temperature Range	-40 to 125 °C		
Rated Maximum Power Dissipation*1	33 mW	66 mW	100 mW
Dissipation Factor*2	Approximately 1 mW/°C	Approximately 2 mW/°C	Approximately 3 mW/°C

- \*1 Rated Maximum Power Dissipation : The maximum power that can be continuously applied at the rated ambient temperature.  
 · The maximum value of power, and rated power is same under the condition of ambient temperature 25 °C or less. If the temperature exceeds 25 °C, rated power depends on the decreased power dissipation curve.  
 · Please see "Operating Power" for details.
- \*2 Dissipation factor : The constant amount power required to raise the temperature of the Thermistor 1 °C through self heat generation under stable temperatures.  
 · Dissipation factor is the reference value when mounted on a glass epoxy board (1.6 mmT).

## Part Number List of Narrow Tolerance Type (Resistance Tolerance : ±2 %, ±1 %)

### ● 0201(EIA)

Part Number	Nominal Resistance at 25 °C	Resistance Tolerance	B Value at 25/50(K)	B Value at 25/85(K)
ERTJZEG103□A	10 kΩ	±1 %(F) or ±2 %(G)	(3380 K)	3435 K±1%
ERTJZEP473□	47 kΩ		4050 K±1 %	(4100 K)
ERTJZER683□	68 kΩ		4250 K±1 %	(4300 K)
ERTJZER104□	100 kΩ		4250 K±1 %	(4300 K)
ERTJZET104□	100 kΩ		4500 K±1 %	(4550 K)
ERTJZEV104□	100 kΩ		4700 K±1 %	(4750 K)

□ : Resistance Tolerance Code

### ● 0402(EIA)

Part Number	Nominal Resistance at 25 °C	Resistance Tolerance	B Value at 25/50(K)	B Value at 25/85(K)
ERTJ0EG103□A	10 kΩ	±1 %(F) or ±2 %(G)	(3380 K)	3435 K±1 %
ERTJ0EP333□	33 kΩ		4050 K±1 %	(4100 K)
ERTJ0EP473□	47 kΩ		4050 K±1 %	(4100 K)
ERTJ0EP683□	68 kΩ		4050 K±1 %	(4100 K)
ERTJ0ES104□	100 kΩ		4330 K±1 %	(4390 K)
ERTJ0EV104□	100 kΩ		4700 K±1 %	(4750 K)

□ : Resistance Tolerance Code

### ● 0603(EIA)

Part Number	Nominal Resistance at 25 °C	Resistance Tolerance	B Value at 25/50(K)	B Value at 25/85(K)
ERTJ1VG103□A	10 kΩ	±1 %(F) or ±2 %(G)	(3380 K)	3435 K±1 %
ERTJ1VS104□A	100 kΩ		(4330 K)	4390 K±1 %

□ : Resistance Tolerance Code

## Part Number List of Standard Type (Resistance Tolerance : ±5 %, ±3 %)

### ● 0201(EIA)

Part Number	Nominal Resistance at 25 °C	Resistance Tolerance	B Value at 25/50(K)	B Value at 25/85(K)
ERTJZET202□	2.0 kΩ	±3 %(H) or ±5 %(J)	4500 K±2 %	(4450 K)
ERTJZET302□	3.0 kΩ		4500 K±2 %	(4450 K)
ERTJZET472□	4.7 kΩ		4500 K±2 %	(4450 K)
ERTJZEG103□A	10 kΩ		(3380 K)	3435 K±1 %
ERTJZEP473□	47 kΩ		4050 K±2 %	(4100 K)
ERTJZER683□	68 kΩ		4250 K±2 %	(4300 K)
ERTJZER104□	100 kΩ		4250 K±2 %	(4300 K)
ERTJZET104□	100 kΩ		4500 K±2 %	(4550 K)
ERTJZEV104□	100 kΩ		4700 K±2 %	(4750 K)

□ : Resistance Tolerance Code

● 0402(EIA)

Part Number	Nominal Resistance at 25 °C	Resistance Tolerance	B Value at 25/50(K)	B Value at 25/85(K)
ERTJ0EA220□	22 Ω	±3 % (H) or ±5 % (J)	2750 K±3 %	(2700 K)
ERTJ0EA330□	33 Ω		2750 K±3 %	(2700 K)
ERTJ0EA400□	40 Ω		2750 K±3 %	(2700 K)
ERTJ0EA470□	47 Ω		2750 K±3 %	(2700 K)
ERTJ0EA680□	68 Ω		2800 K±3 %	(2750 K)
ERTJ0EA101□	100 Ω		2800 K±3 %	(2750 K)
ERTJ0EA151□	150 Ω		2800 K±3 %	(2750 K)
ERTJ0ET102□	1.0 kΩ		4500 K±2 %	(4450 K)
ERTJ0ET152□	1.5 kΩ		4500 K±2 %	(4450 K)
ERTJ0ET202□	2.0 kΩ		4500 K±2 %	(4450 K)
ERTJ0ET222□	2.2 kΩ		4500 K±2 %	(4450 K)
ERTJ0ET302□	3.0 kΩ		4500 K±2 %	(4450 K)
ERTJ0ER332□	3.3 kΩ		4250 K±2 %	(4300 K)
ERTJ0ET332□	3.3 kΩ		4500 K±2 %	(4450 K)
ERTJ0ET472□	4.7 kΩ		4500 K±2 %	(4450 K)
ERTJ0ER472□	4.7 kΩ		4250 K±2 %	(4300 K)
ERTJ0ER682□	6.8 kΩ		4250 K±2 %	(4300 K)
ERTJ0EG103□A	10 kΩ		(3380 K)	3435 K±1 %
ERTJ0EM103□	10 kΩ		3900 K±2 %	(3970 K)
ERTJ0ER103□	10 kΩ		4250 K±2 %	(4300 K)
ERTJ0ER153□	15 kΩ		4250 K±2 %	(4300 K)
ERTJ0ER223□	22 kΩ		4250 K±2 %	(4300 K)
ERTJ0EP333□	33 kΩ		4050 K±2 %	(4100 K)
ERTJ0ER333□	33 kΩ		4250 K±2 %	(4300 K)
ERTJ0ET333□	33 kΩ		4500 K±2 %	(4580 K)
ERTJ0EP473□	47 kΩ		4050 K±2 %	(4100 K)
ERTJ0EV473□	47 kΩ		4700 K±2 %	(4750 K)
ERTJ0EP683□	68 kΩ		4050 K±2 %	(4100 K)
ERTJ0ER683□	68 kΩ		4250 K±2 %	(4300 K)
ERTJ0EV683□	68 kΩ		4700 K±2 %	(4750 K)
ERTJ0ER104□	100 kΩ		4250 K±2 %	(4300 K)
ERTJ0ES104□	100 kΩ		4330 K±2 %	(4390 K)
ERTJ0ET104□	100 kΩ		4500 K±2 %	(4580 K)
ERTJ0EV104□	100 kΩ	4700 K±2 %	(4750 K)	
ERTJ0ET154□	150 kΩ	4500 K±2 %	(4580 K)	
ERTJ0EV154□	150 kΩ	4700 K±2 %	(4750 K)	
ERTJ0EV224□	220 kΩ	4700 K±2 %	(4750 K)	
ERTJ0EV334□	330 kΩ	4700 K±2 %	(4750 K)	
ERTJ0EV474□	470 kΩ	4700 K±2 %	(4750 K)	

□ : Resistance Tolerance Code

● 0603(EIA)

Part Number	Nominal Resistance at 25 °C	Resistance Tolerance	B Value at 25/50(K)	B Value at 25/85(K)
ERTJ1VA220□	22 Ω	±3 %(H) or ±5 %(J)	2750 K±3 %	(2700 K)
ERTJ1VA330□	33 Ω		2750 K±3 %	(2700 K)
ERTJ1VA400□	40 Ω		2800 K±3 %	(2750 K)
ERTJ1VA470□	47 Ω		2800 K±3 %	(2750 K)
ERTJ1VA680□	68 Ω		2800 K±3 %	(2750 K)
ERTJ1VA101□	100 Ω		2800 K±3 %	(2750 K)
ERTJ1VT102□	1.0 kΩ		4500 K±2 %	(4450 K)
ERTJ1VT152□	1.5 kΩ		4500 K±2 %	(4450 K)
ERTJ1VT202□	2.0 kΩ		4500 K±2 %	(4450 K)
ERTJ1VT222□	2.2 kΩ		4500 K±2 %	(4450 K)
ERTJ1VT302□	3.0 kΩ		4500 K±2 %	(4450 K)
ERTJ1VT332□	3.3 kΩ		4500 K±2 %	(4450 K)
ERTJ1VR332□	3.3 kΩ		4250 K±2 %	(4300 K)
ERTJ1VR472□	4.7 kΩ		4250 K±2 %	(4300 K)
ERTJ1VT472□	4.7 kΩ		4500 K±2 %	(4450 K)
ERTJ1VR682□	6.8 kΩ		4250 K±2 %	(4300 K)
ERTJ1VG103□A	10 kΩ		(3380 K)	3435 K±1%
ERTJ1VR103□	10 kΩ		4250 K±2 %	(4300 K)
ERTJ1VR153□	15 kΩ		4250 K±2 %	(4300 K)
ERTJ1VR223□	22 kΩ		4250 K±2 %	(4300 K)
ERTJ1VR333□	33 kΩ		4250 K±2 %	(4300 K)
ERTJ1VP473□	47 kΩ		4100 K±2 %	(4150 K)
ERTJ1VR473□	47 kΩ		4250 K±2 %	(4300 K)
ERTJ1VV473□	47 kΩ		4700 K±2 %	(4750 K)
ERTJ1VR683□	68 kΩ		4250 K±2 %	(4300 K)
ERTJ1VV683□	68 kΩ		4700 K±2 %	(4750 K)
ERTJ1VS104□A	100 kΩ		(4330 K)	4390 K±1%
ERTJ1VV104□	100 kΩ		4700 K±2 %	(4750 K)
ERTJ1VV154□	150 kΩ		4700 K±2 %	(4750 K)
ERTJ1VT224□	220 kΩ		4500 K±2 %	(4580 K)

□ : Resistance Tolerance Code

● Temperature and Resistance value (the resistance value at 25 °C is set to 1)/ Reference values

	ERTJ□□A~		ERTJ□□G~	ERTJ□□M~	ERTJ□□P~	ERTJ□□R~	ERTJ0ES~	ERTJ1VS~	ERTJ□□T~	ERTJ0ET104□	ERTJ□□V~
B <sub>25/50</sub>	2750 K	2800 K	(3375 K)	3900 K	4050 K	4250 K	4330 K	(4330 K)	4500 K	4500 K	4700 K
B <sub>25/85</sub>	(2700 K)	(2750 K)	3435 K	(3970 K)	(4100 K)	(4300 K)	(4390 K)	4390 K	(4450 K)	(4580 K)	(4750 K)
T(°C)									*1	*2	
-40	13.05	13.28	20.52	32.11	33.10	43.10	45.67	45.53	63.30	47.07	59.76
-35	10.21	10.40	15.48	23.29	24.03	30.45	32.08	31.99	42.92	33.31	41.10
-30	8.061	8.214	11.79	17.08	17.63	21.76	22.80	22.74	29.50	23.80	28.61
-25	6.427	6.547	9.069	12.65	13.06	15.73	16.39	16.35	20.53	17.16	20.14
-20	5.168	5.261	7.037	9.465	9.761	11.48	11.91	11.89	14.46	12.49	14.33
-15	4.191	4.261	5.507	7.147	7.362	8.466	8.743	8.727	10.30	9.159	10.31
-10	3.424	3.476	4.344	5.444	5.599	6.300	6.479	6.469	7.407	6.772	7.482
-5	2.819	2.856	3.453	4.181	4.291	4.730	4.845	4.839	5.388	5.046	5.481
0	2.336	2.362	2.764	3.237	3.312	3.582	3.654	3.650	3.966	3.789	4.050
5	1.948	1.966	2.227	2.524	2.574	2.734	2.778	2.776	2.953	2.864	3.015
10	1.635	1.646	1.806	1.981	2.013	2.102	2.128	2.126	2.221	2.179	2.262
15	1.380	1.386	1.474	1.567	1.584	1.629	1.642	1.641	1.687	1.669	1.710
20	1.171	1.174	1.211	1.247	1.255	1.272	1.277	1.276	1.293	1.287	1.303
25	1	1	1	1	1	1	1	1	1	1	1
30	0.8585	0.8565	0.8309	0.8072	0.8016	0.7921	0.7888	0.7890	0.7799	0.7823	0.7734
35	0.7407	0.7372	0.6941	0.6556	0.6461	0.6315	0.6263	0.6266	0.6131	0.6158	0.6023
40	0.6422	0.6376	0.5828	0.5356	0.5235	0.5067	0.5004	0.5007	0.4856	0.4876	0.4721
45	0.5595	0.5541	0.4916	0.4401	0.4266	0.4090	0.4022	0.4025	0.3874	0.3884	0.3723
50	0.4899	0.4836	0.4165	0.3635	0.3496	0.3319	0.3251	0.3254	0.3111	0.3111	0.2954
55	0.4309	0.4238	0.3543	0.3018	0.2881	0.2709	0.2642	0.2645	0.2513	0.2504	0.2356
60	0.3806	0.3730	0.3027	0.2518	0.2386	0.2222	0.2158	0.2161	0.2042	0.2026	0.1889
65	0.3376	0.3295	0.2595	0.2111	0.1985	0.1832	0.1772	0.1774	0.1670	0.1648	0.1523
70	0.3008	0.2922	0.2233	0.1777	0.1659	0.1518	0.1463	0.1465	0.1377	0.1348	0.1236
75	0.2691	0.2600	0.1929	0.1504	0.1393	0.1264	0.1213	0.1215	0.1144	0.1108	0.1009
80	0.2417	0.2322	0.1672	0.1278	0.1174	0.1057	0.1011	0.1013	0.09560	0.09162	0.08284
85	0.2180	0.2081	0.1451	0.1090	0.09937	0.08873	0.08469	0.08486	0.08033	0.07609	0.06834
90	0.1974	0.1871	0.1261	0.09310	0.08442	0.07468	0.07122	0.07138	0.06782	0.06345	0.05662
95	0.1793	0.1688	0.1097	0.07980	0.07200	0.06307	0.06014	0.06028	0.05753	0.05314	0.04712
100	0.1636	0.1528	0.09563	0.06871	0.06166	0.05353	0.05099	0.05112	0.04903	0.04472	0.03939
105	0.1498	0.1387	0.08357	0.05947	0.05306	0.04568	0.04340	0.04351	0.04198	0.03784	0.03308
110	0.1377	0.1263	0.07317	0.05170	0.04587	0.03918	0.03708	0.03718	0.03609	0.03218	0.02791
115	0.1270	0.1153	0.06421	0.04512	0.03979	0.03374	0.03179	0.03188	0.03117	0.02748	0.02364
120	0.1175	0.1056	0.05650	0.03951	0.03460	0.02916	0.02734	0.02742	0.02702	0.02352	0.02009
125	0.1091	0.09695	0.04986	0.03470	0.03013	0.02527	0.02359	0.02367	0.02351	0.02017	0.01712

\*1 Applied to the product except for ERTJ0ET104□ in B<sub>25/50</sub>=4500 K.

\*2 Applied only to ERTJ0ET104□.

$$B_{25/50} = \frac{\ln(R_{25}/R_{50})}{1/298.15 - 1/323.15}$$

$$B_{25/85} = \frac{\ln(R_{25}/R_{85})}{1/298.15 - 1/358.15}$$

R<sub>25</sub>=Resistance at 25.0±0.1 °C

R<sub>50</sub>=Resistance at 50.0±0.1 °C

R<sub>85</sub>=Resistance at 85.0±0.1 °C

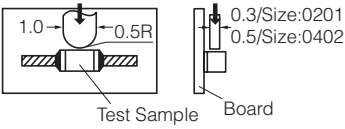
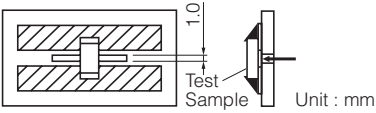
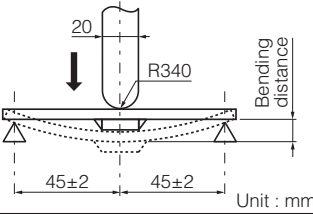

## Specification and Test Method

Item	Specification	Test Method									
Rated Zero-power Resistance (R <sub>25</sub> )	Within the specified tolerance.	The value is measured at a power that the influence of self-heat generation can be negligible (0.1mW or less), at the rated ambient temperature of 25.0±0.1°C.									
B Value	Shown in each Individual Specification. * Individual Specification shall specify B <sub>25/50</sub> or B <sub>25/85</sub> .	<p>The Zero-power resistances; R<sub>1</sub> and R<sub>2</sub>, shall be measured respectively at T<sub>1</sub> (deg.C) and T<sub>2</sub> (deg.C). The B value is calculated by the following equation.</p> $B_{T_1/T_2} = \frac{\ln(R_1) - \ln(R_2)}{1/(T_1 + 273.15) - 1/(T_2 + 273.15)}$ <table border="1"> <thead> <tr> <th></th> <th>T<sub>1</sub></th> <th>T<sub>2</sub></th> </tr> </thead> <tbody> <tr> <td>B<sub>25/50</sub></td> <td>25.0 ±0.1 °C</td> <td>50.0 ±0.1 °C</td> </tr> <tr> <td>B<sub>25/85</sub></td> <td>25.0 ±0.1 °C</td> <td>85.0 ±0.1 °C</td> </tr> </tbody> </table>		T <sub>1</sub>	T <sub>2</sub>	B <sub>25/50</sub>	25.0 ±0.1 °C	50.0 ±0.1 °C	B <sub>25/85</sub>	25.0 ±0.1 °C	85.0 ±0.1 °C
	T <sub>1</sub>	T <sub>2</sub>									
B <sub>25/50</sub>	25.0 ±0.1 °C	50.0 ±0.1 °C									
B <sub>25/85</sub>	25.0 ±0.1 °C	85.0 ±0.1 °C									
Adhesion	The terminal electrode shall be free from peeling or signs of peeling.	<p>Applied force : Size 0201 : 2 N Size 0402, 0603 : 5 N Duration : 10 s</p> <p>Size : 0201, 0402</p>  <p>Size : 0603</p>  <p>Unit : mm</p>									
Bending Strength	There shall be no cracks and other mechanical damage. R <sub>25</sub> change : within ±5 %	<p>Bending distance : 1 mm Bending speed : 1 mm/s</p>  <p>Unit : mm</p>									
Resistance to Soldering Heat	There shall be no cracks and other mechanical damage. Narrow Tol. type    Standard type R <sub>25</sub> change : within ±2 %    within ±3 % B Value change : within ±1 %    within ±2 %	<p>Soldering bath method Solder temperature : 270 ±5 °C Dipping period : 4.0 ±1 s Preheat condition :</p> <table border="1"> <thead> <tr> <th>Step</th> <th>Temp (°C)</th> <th>Period (s)</th> </tr> </thead> <tbody> <tr> <td>1</td> <td>80 to 100</td> <td>120 to 180</td> </tr> <tr> <td>2</td> <td>150 to 200</td> <td>120 to 180</td> </tr> </tbody> </table>	Step	Temp (°C)	Period (s)	1	80 to 100	120 to 180	2	150 to 200	120 to 180
Step	Temp (°C)	Period (s)									
1	80 to 100	120 to 180									
2	150 to 200	120 to 180									
Solderability	More than 95 % of the soldered area of both terminal electrodes shall be covered with fresh solder.	<p>Soldering bath method Solder temperature : 230 ±5 °C Dipping period : 4 ±1 s Solder : Sn-3.0Ag-0.5Cu</p>									

## Specification and Test Method

Item	Specification		Test Method
Temperature Cycling	Narrow Tol. type R <sub>25</sub> change : within ±2 % B Value change : within ±1 %	Standard type within ±3 % within ±2 %	Conditions of one cycle Step 1 : -40 °C, 30±3 min Step 2 : Room temp., 3 min max. Step 3 : 125 °C, 30±3 min. Step 4 : Room temp., 3 min max. Number of cycles: 100 cycles
Humidity	Narrow Tol. type R <sub>25</sub> change : within ±2 % B Value change : within ±1 %	Standard type within ±3 % within ±2 %	Temperature : 85 ±2 °C Relative humidity : 85 ±5 % Test period : 1000 +48/0 h
Biased Humidity	Narrow Tol. type R <sub>25</sub> change : within ±2 % B Value change : within ±1 %	Standard type within ±3 % within ±2 %	Temperature : 85 ±2 °C Relative humidity : 85 ±5 % Applied power : 10 mW(D.C.) Test period : 500 +48/0 h
Low Temperature Exposure	Narrow Tol. type R <sub>25</sub> change : within ±2 % B Value change : within ±1 %	Standard type within ±3 % within ±2 %	Specimens are soldered on the testing board shown in Fig.2. Temperature : -40 ±3 °C Test period : 1000 +48/0 h
High Temperature Exposure	Narrow Tol. type R <sub>25</sub> change : within ±2 % B Value change : within ±1 %	Standard type within ±3 % within ±2 %	Specimens are soldered on the testing board shown in Fig.2. Temperature : 125 ±3 °C Test period : 1000 +48/0 h

## Typical Application

### ● Temperature Detection

Writing current control of HDD

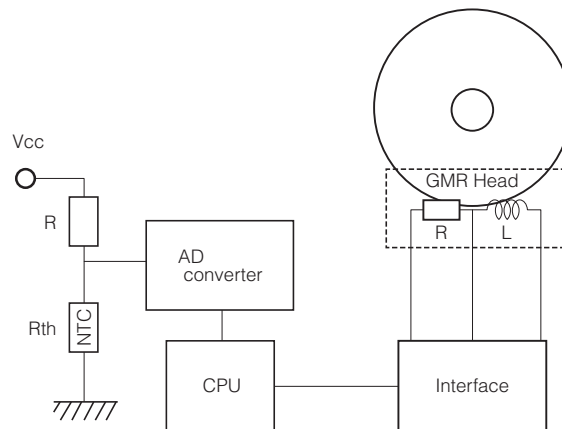

### ● Temperature Compensation (Pseudo-linearization)

Contrast level control of LCD

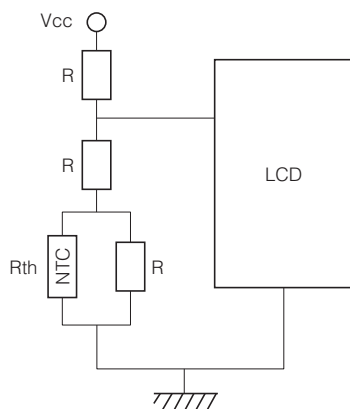

### ● Temperature Compensation (RF circuit)

Temperature compensation of TCXO

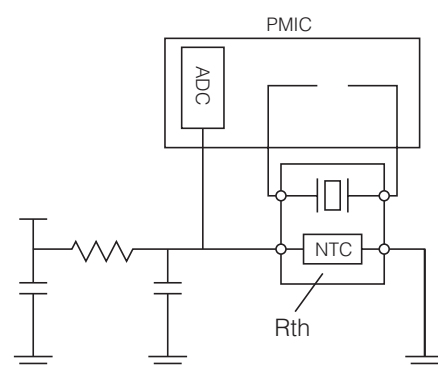

## Dimensions in mm (not to scale)

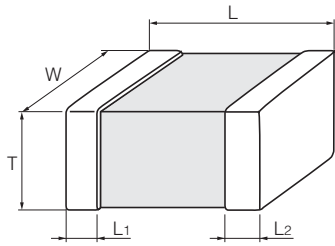

(Unit : mm)

Size Code (EIA)	L	W	T	L <sub>1</sub> , L <sub>2</sub>
Z(0201)	0.60±0.03	0.30±0.03	0.30±0.03	0.15±0.05
0(0402)	1.0±0.1	0.50±0.05	0.50±0.05	0.25±0.15
1(0603)	1.60±0.15	0.8±0.1	0.8±0.1	0.3±0.2

## Packaging Methods

### ● Standard Packing Quantities

Size Code	Thickness (mm)	Kind of Taping	Pitch (mm)	Quantity (pcs./reel)
Z(0201)	0.3	Pressed Carrier Taping	2	15,000
0(0402)	0.5	Punched Carrier Taping	2	10,000
1(0603)	0.8		4	4,000

### ● Pitch 2 mm (Pressed Carrier Taping) : Size 0201

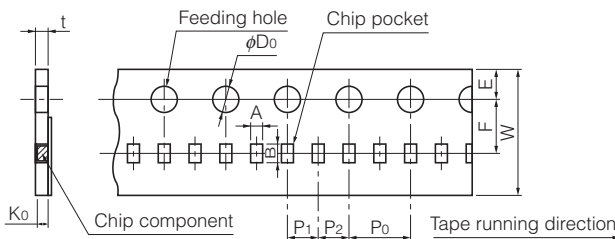

Symbol	A	B	W	F	E	P <sub>1</sub>	P <sub>2</sub>	P <sub>0</sub>	φD <sub>0</sub>	t	K <sub>0</sub>
Dim. (mm)	0.36 ±0.03	0.66 ±0.03	8.0 ±0.2	3.50 ±0.05	1.75 ±0.10	2.00 ±0.05	2.00 ±0.05	4.0 ±0.1	1.5 <sup>+0.1</sup> <sub>0</sub>	0.55 max.	0.36 ±0.03

### ● Pitch 2 mm (Punched Carrier Taping) : Size 0402

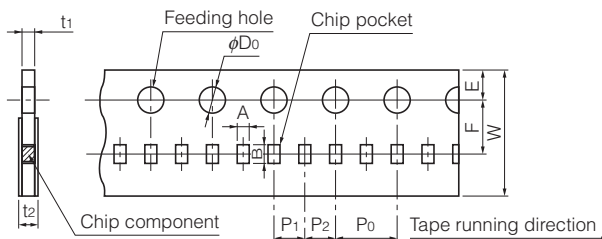

Symbol	A	B	W	F	E	P <sub>1</sub>	P <sub>2</sub>	P <sub>0</sub>	φD <sub>0</sub>	t <sub>1</sub>	t <sub>2</sub>
Dim. (mm)	0.62 ±0.05	1.12 ±0.05	8.0 ±0.2	3.50 ±0.05	1.75 ±0.10	2.00 ±0.05	2.00 ±0.05	4.0 ±0.1	1.5 <sup>+0.1</sup> <sub>0</sub>	0.7 max.	1.0 max.

### ● Pitch 4 mm (Punched Carrier Taping) : Size 0603

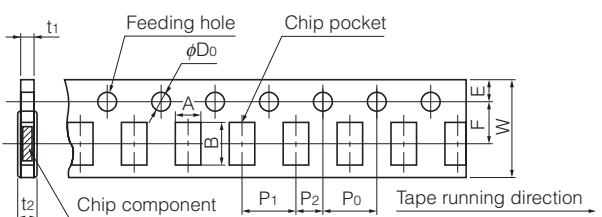

Symbol	A	B	W	F	E	P <sub>1</sub>	P <sub>2</sub>	P <sub>0</sub>	φD <sub>0</sub>	t <sub>1</sub>	t <sub>2</sub>
Dim. (mm)	1.0 ±0.1	1.8 ±0.1	8.0 ±0.2	3.50 ±0.05	1.75 ±0.10	4.0 ±0.1	2.00 ±0.05	4.0 ±0.1	1.5 <sup>+0.1</sup> <sub>0</sub>	1.1 max.	1.4 max.

### ● Reel for Taping

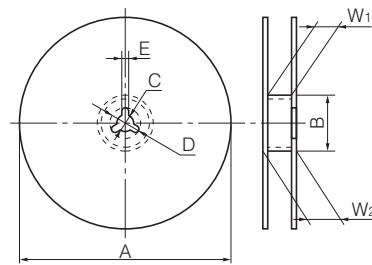

Symbol	φA	φB	C	D	E	W <sub>1</sub>	W <sub>2</sub>
Dim. (mm)	180 <sup>-0.3</sup>	60.0 <sup>+1.0</sup> <sub>0</sub>	13.0±0.5	21.0±0.8	2.0±0.5	9.0 <sup>+1.0</sup> <sub>0</sub>	11.4±1.0

### ● Leader Part and Taped End

#### Leader part

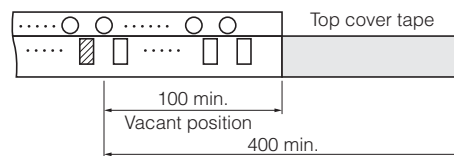

#### Taped end

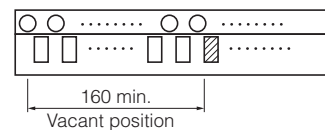

(Unit : mm)

## Minimum Quantity / Packing Unit

Part Number (Size)	Minimum Quantity / Packing Unit	Packing Quantity in Carton	Carton L×W×H (mm)
ERTJZ (0201)	15,000	300,000	250×200×200
ERTJ0 (0402)	10,000	200,000	250×200×200
ERTJ1 (0603)	4,000	80,000	250×200×200

Part No., quantity and country of origin are designated on outer packages in English.

## Multilayer NTC Thermistors

Series: **ERTJ**

### Handling Precautions

#### ⚠ Safety Precautions

Multilayer NTC Thermistors (hereafter referred to as “Thermistors”) should be used for general purpose applications found in consumer electronics (audio/visual, home, office, information & communication) equipment.

When subjected to severe electrical, environmental, and/or mechanical stress beyond the specifications, as noted in the Ratings and Specified Conditions section, the Thermistors’ performance may be degraded, or become failure mode, such as short circuit mode and open-circuit mode. If you use under the condition of short-circuit, heat generation of thermistors will occur by running large current due to application of voltage. There are possibilities of smoke emission, substrate burn-out, and, in the worst case, fire.

For products which require higher safety levels, please carefully consider how a single malfunction can affect your product. In order to ensure the safety in the case of a single malfunction, please design products with fail-safe, such as setting up protecting circuits, etc.

- For the following applications and conditions, please contact us for product of special specification not found in this document.
  - When your application may have difficulty complying with the safety or handling precautions specified below.
  - High-quality and high-reliability required devices that have possibility of causing hazardous conditions, such as death or injury (regardless of directly or indirectly), due to failure or malfunction of the product.
    - ① Aircraft and Aerospace Equipment (artificial satellite, rocket, etc.)
    - ② Submarine Equipment (submarine repeating equipment, etc.)
    - ③ Transportation Equipment (motor vehicles, airplanes, trains, ship, traffic signal controllers, etc.)
    - ④ Power Generation Control Equipment (atomic power, hydroelectric power, thermal power plant control system, etc.)
    - ⑤ Medical Equipment (life-support equipment, pacemakers, dialysis controllers, etc.)
    - ⑥ Information Processing Equipment (large scale computer systems, etc.)
    - ⑦ Electric Heating Appliances, Combustion devices (gas fan heaters, oil fan heaters, etc.)
    - ⑧ Rotary Motion Equipment
    - ⑨ Security Systems
    - ⑩ And any similar types of equipment

### Operating Conditions and Circuit Design

#### 1. Circuit Design

##### 1.1 Operating Temperature and Storage Temperature

When operating a components-mounted circuit, please be sure to observe the “Operating Temperature Range”, written in delivery specifications. Please remember not to use the product under the condition that exceeds the specified maximum temperature.

Storage temperature of PCB after mounting Thermistors, which is not operated, should be within the specified “Storage Temperature Range” in the delivery specifications.

##### 1.2 Operating Power

The electricity applied to between terminals of Thermistors should be under the specified maximum power dissipation.

There are possibilities of breakage and burn-out due to excessive self-heating of Thermistors, if the power exceeds maximum power dissipation when operating. Please consider installing protection circuit for your circuit to improve the safety, in case of abnormal voltage application and so on.

Thermistors’ performance of temperature detection would be deteriorated if self-heating occurs, even when you use it under the maximum power dissipation.

Please consider the maximum power dissipation and dissipation factor.

#### [Maximum power dissipation]

- The Maximum power that can be continuously applied under static air at a certain ambient temperature. The Maximum power dissipation under an ambient temperature of 25 °C or less is the same with the rated maximum power dissipation, and Maximum power dissipation beyond 25 °C depends on the Decreased power dissipation curve below.

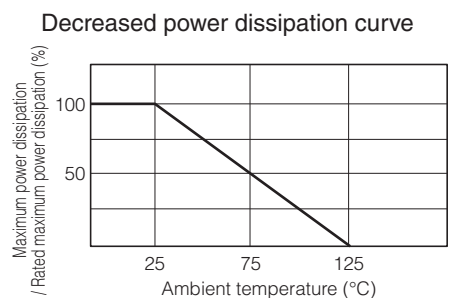

#### [Dissipation factor]

- The constant amount power required to raise the temperature of the Thermistor 1 °C through self heat generation under stable temperatures.  
 Dissipation factor (mW/°C) = Power consumption of Thermistor / Temperature rise of element

### 1.3 Environmental Restrictions

The Thermistors shall not be operated and/or stored under the following conditions.

- (1) Environmental conditions
  - (a) Under direct exposure to water or salt water
  - (b) Under conditions where water can condense and/or dew can form
  - (c) Under conditions containing corrosive gases such as hydrogen sulfide, sulfurous acid, chlorine and ammonia
- (2) Mechanical conditions
 

The place where vibration or impact that exceeds specified conditions written in delivery specification is loaded.

### 1.4 Measurement of Resistance

The resistance of the Thermistors varies depending on ambient temperatures and self-heating. To measure the resistance value when examining circuit configuration and conducting receiving inspection and so on, the following points should be taken into consideration:

- ① Measurement temp :  $25 \pm 0.1$  °C  
Measurement in liquid (silicon oil, etc.) is recommended for a stable measurement temperature.
- ② Power : 0.10 mW max.  
4 terminal measurement with a constant-current power supply is recommended.

## 2. Design of Printed Circuit Board

### 2.1 Selection of Printed Circuit Boards

There is a possibility of performance deterioration by heat shock (temperature cycles), which causes cracks, from alumina substrate.

Please confirm that the substrate you use does not deteriorate the Thermistors' quality.

### 2.2 Design of Land Pattern

- (1) Recommended land dimensions are shown below. Use the proper amount of solder in order to prevent cracking. Using too much solder places excessive stress on the Thermistors.

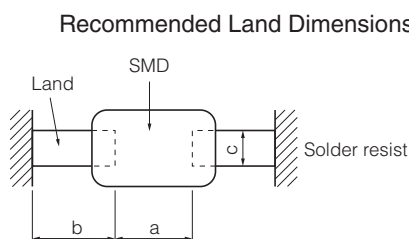

Unit (mm)

Size Code (EIA)	Component dimensions			a	b	c
	L	W	T			
Z(0201)	0.6	0.3	0.3	0.2 to 0.3	0.25 to 0.30	0.2 to 0.3
Q(0402)	1.0	0.5	0.5	0.4 to 0.5	0.4 to 0.5	0.4 to 0.5
1(0603)	1.6	0.8	0.8	0.8 to 1.0	0.6 to 0.8	0.6 to 0.8

- (2) The land size shall be designed to have equal space, on both right and left sides. If the amount of solder on both sides is not equal, the component may be cracked by stress, since the side with a larger amount of solder solidifies later during cooling.

### Recommended Amount of Solder

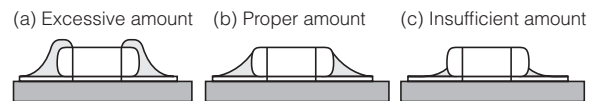

### 2.3 Utilization of Solder Resist

- (1) Solder resist shall be utilized to equalize the amounts of solder on both sides.
- (2) Solder resist shall be used to divide the pattern for the following cases;
  - Components are arranged closely.
  - The Thermistor is mounted near a component with lead wires.
  - The Thermistor is placed near a chassis.
 Refer to the table below.

### Prohibited Applications and Recommended Applications

Item	Prohibited applications	Improved applications by pattern division
Mixed mounting with a component with lead wires	The lead wire of a component with lead wires	Solder resist
Arrangement near chassis	Chassis Solder (Ground solder) Electrode pattern	Solder resist
Retro-fitting of component with lead wires	Soldering iron A lead wire of Retro-fitted component	Solder resist
Lateral arrangement	Portion to be excessively soldered Land	Solder resist

### 2.4 Component Layout

To prevent the crack of Thermistors, try to place it on the position that could not easily be affected by the bending stress of substrate while mounting procedures or procedures afterwards.

Placement of the Thermistors near heating elements also requires the great care to be taken in order to avoid stresses from rapid heating and cooling.

- (1) To minimize mechanical stress caused by the warp or bending of a PC board, please follow the recommended Thermistors' layout below.

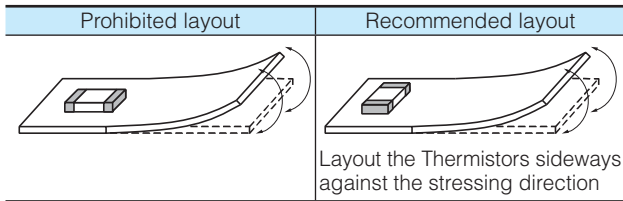

- (2) The following layout is for your reference since mechanical stress near the dividing/breaking position of a PC board varies depending on the mounting position of the Thermistors.

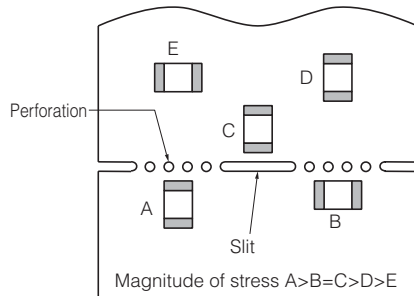

- (3) The magnitude of mechanical stress applied to the Thermistors when dividing the circuit board in descending order is as follows:  
push back < slit < V-groove < perforation.  
Also take into account the layout of the Thermistors and the dividing/breaking method.
- (4) When the Thermistors are placed near heating elements such as heater, etc., cracks from thermal stresses may occur under following situation:
- Soldering the Thermistors directly to heating elements.
  - Sharing the land with heating elements.
- If planning to conduct above-mentioned mounting and/or placement, please contact us in advance.

## 2.5 Mounting Density and Spaces

Intervals between components should not be too narrow to prevent the influence from solder bridges and solder balls. The space between components should be carefully determined.

## Precautions for Assembly

### 1. Storage



- (1) The Thermistors shall be stored between 5 to 40 °C and 20 to 70 % RH, not under severe conditions of high temperature and humidity.
- (2) If stored in a place where humidity, dust, or corrosive gasses (hydrogen sulfide, sulfurous acid, hydrogen chloride and ammonia, etc.) are contained, the solderability of terminal electrodes will be deteriorated.  
In addition, storage in a places where the heat or direct sunlight exposure occur will cause mounting problems due to deformation of tapes and reels and components and taping/reels sticking together.
- (3) Do not store components longer than 6 months. Check the solderability of products that have been stored for more than 6 months before use

### 2. Chip Mounting Consideration

- (1) When mounting the Thermistors/components on a PC board, the Thermistor bodies shall be free from excessive impact loads such as mechanical impact or stress due to the positioning, pushing force and displacement of vacuum nozzles during mounting.
- (2) Maintenance and inspection of the Chip Mounter must be performed regularly.
- (3) If the bottom dead center of the vacuum nozzle is too low, the Thermistor will crack from excessive force during mounting.

The following precautions and recommendations are for your reference in use.

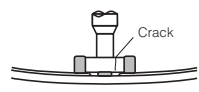
- (a) Set and adjust the bottom dead center of the vacuum nozzles to the upper surface of the PC board after correcting the warp of the PC board.
- (b) Set the pushing force of the vacuum nozzle during mounting to 1 to 3 N in static load.
- (c) For double surface mounting, apply a supporting pin on the rear surface of the PC board to suppress the bending of the PC board in order to minimize the impact of the vacuum nozzles. Typical examples are shown in the table below.

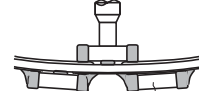
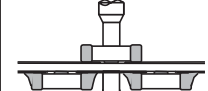
Item	Prohibited mounting	Recommended mounting
Single surface mounting		 The supporting pin does not necessarily have to be positioned beneath the Thermistor.
Double surface mounting		

- (d) Adjust the vacuum nozzles so that their bottom dead center during mounting is not too low.
- (4) The closing dimensions of the positioning chucks shall be controlled. Maintenance and replacement of positioning chucks shall be performed regularly to prevent chipping or cracking of the Thermistors caused by mechanical impact during positioning due to worn positioning chucks.
  - (5) Maximum stroke of the nozzle shall be adjusted so that the maximum bending of PC board does not exceed 0.5 mm at 90 mm span. The PC board shall be supported by an adequate number of supporting pins.

### 3. Selection of Soldering Flux

Soldering flux may seriously affect the performance of the Thermistors. The following shall be confirmed before use.

- (1) The soldering flux should have a halogen based content of 0.1 wt% (converted to chlorine) or below. Do not use soldering flux with strong acid.
- (2) When applying water-soluble soldering flux, wash the Thermistors sufficiently because the soldering flux residue on the surface of PC boards may deteriorate the insulation resistance on the Thermistors' surface.

## 4. Soldering

### 4.1 Reflow Soldering

The reflow soldering temperature conditions are composed of temperature curves of Preheating, Temp. rise, Heating, Peak and Gradual cooling. Large temperature difference inside the Thermistors caused by rapid heat application to the Thermistors may lead to excessive thermal stresses, contributing to the thermal cracks. The Preheating temperature requires controlling with great care so that tombstone phenomenon may be prevented.

Item	Temperature	Period or Speed
①Preheating	140 to 180 °C	60 to 120 sec
②Temp. rise	Preheating temp to Peak temp.	2 to 5 °C /sec
③Heating	220 °C min.	60 sec max.
④Peak	260 °C max.	10 sec max.
⑤Gradual cooling	Peak temp. to 140 °C	1 to 4 °C /sec

#### Recommended profile of Reflow soldering (EX)

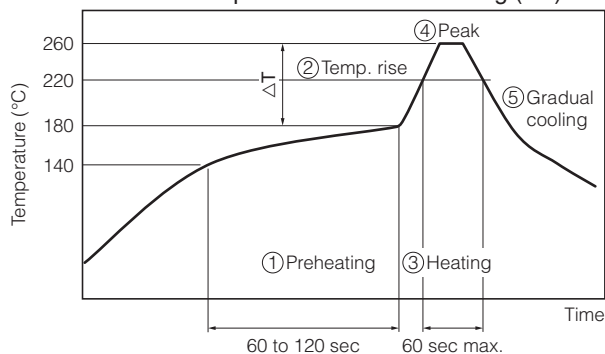

$\Delta T$  : Allowable temperature difference  $\Delta T \leq 150 \text{ }^\circ\text{C}$

The rapid cooling (forced cooling) during Gradual cooling part should be avoided, because this may cause defects such as the thermal cracks, etc. When the Thermistors are immersed into a cleaning solvent, make sure that the surface temperatures of the devices do not exceed 100 °C. Performing reflow soldering twice under the conditions shown in the figure above [Recommended profile of Reflow soldering (EX)] will not cause any problems. However, pay attention to the possible warp and bending of the PC board.

### 4.2 Hand Soldering

Hand soldering typically causes significant temperature change, which may induce excessive thermal stresses inside the Thermistors, resulting in the thermal cracks, etc. In order to prevent any defects, the following should be observed.

- The temperature of the soldering tips should be controlled with special care.
- The direct contact of soldering tips with the Thermistors and/or terminal electrodes should be avoided.
- Dismounted Thermistors shall not be reused.

#### (1) Condition 1 (with preheating)

##### (a) Soldering:

Use thread solder ( $\phi 1$  mm or below) which contains flux with low chlorine, developed for precision electronic equipment.

#### (b) Preheating:

Conduct sufficient pre-heating, and make sure that the temperature difference between solder and Thermistors' surface is 150 °C or less.

#### (c) Temperature of Iron tip: 300 °C max.

(The required amount of solder shall be melted in advance on the soldering tip.)

#### (d) Gradual cooling:

After soldering, the Thermistors shall be cooled gradually at room temperature.

#### Recommended profile of Hand soldering (EX)

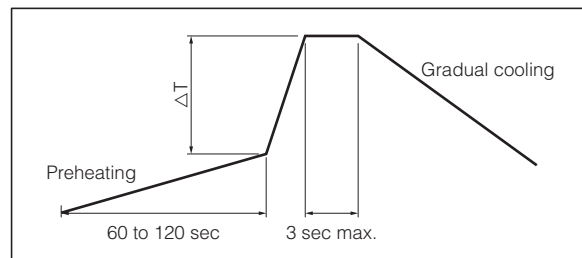

$\Delta T$  : Allowable temperature difference  $\Delta T \leq 150 \text{ }^\circ\text{C}$

#### (2) Condition 2 (without preheating)

Hand soldering can be performed without preheating, by following the conditions below:

- (a) Soldering iron tip shall never directly touch the ceramic and terminal electrodes of the Thermistors.
- (b) The lands are sufficiently preheated with a soldering iron tip before sliding the soldering iron tip to the terminal electrodes of the Thermistors for soldering.

#### Conditions of Hand soldering without preheating

Item	Condition
Temperature of Iron tip	270 °C max.
Wattage	20 W max.
Shape of Iron tip	$\phi 3$ mm max.
Soldering time with a soldering iron	3 sec max.

## 5. Post Soldering Cleaning

### 5.1 Cleaning solvent

Soldering flux residue may remain on the PC board if cleaned with an inappropriate solvent. This may deteriorate the electrical characteristics and reliability of the Thermistors.

### 5.2 Cleaning conditions

Inappropriate cleaning conditions such as insufficient cleaning or excessive cleaning may impair the electrical characteristics and reliability of the Thermistors.

#### (1) Insufficient cleaning can lead to:

- (a) The halogen substance found in the residue of the soldering flux may cause the metal of terminal electrodes to corrode.
- (b) The halogen substance found in the residue of the soldering flux on the surface of the Thermistors may change resistance values.
- (c) Water-soluble soldering flux may have more remarkable tendencies of (a) and (b) above compared to those of rosin soldering flux.

- (2) Excessive cleaning can lead to:
- When using ultrasonic cleaner, make sure that the output is not too large, so that the substrate will not resonate. The resonance causes the cracks in Varistors and/or solders, and deteriorates the strength of the terminal electrodes. Please follow these conditions for Ultrasonic cleaning:  
 Ultrasonic wave output : 20 W/L max.  
 Ultrasonic wave frequency : 40 kHz max.  
 Ultrasonic wave cleaning time : 5 min. max.

### 5.3 Contamination of Cleaning solvent

Cleaning with contaminated cleaning solvent may cause the same results as insufficient cleaning due to the high density of liberated halogen.

## 6. Inspection Process

The pressure from measuring terminal pins might bend the PCB when implementing circuit inspection after mounting Thermistors on PCB, and as a result, cracking may occur.

- Mounted PC boards shall be supported by an adequate number of supporting pins on the back with bend settings of 90 mm span 0.5 mm max.
- Confirm that the measuring pins have the right tip shape, are equal in height, have the right pressure, and are set in the correct positions. The following figures are for your reference to avoid bending the PC board.

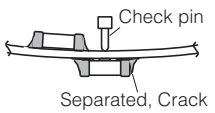
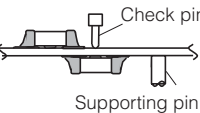
Item	Prohibited setting	Recommended setting
Bending of PC board	 Separated, Crack	 Supporting pin

## 7. Protective Coating

When the surface of a PC board on which the Thermistors have been mounted is coated with resin to protect against moisture and dust, it shall be confirmed that the protective coating does not affect the performance of Varistors.

- Choose the material that does not emit the decomposition and/or reaction gas. The Gas may affect the composing members of the Varistors.
- Shrinkage and expansion of resin coating when curing may apply stress to the Varistors and may lead to occurrence of cracks.

## 8. Dividing/Breaking of PC Boards

- Please be careful not to stress the substrate with bending/twisting when dividing, after mounting components including Varistors. Abnormal and excessive mechanical stress such as bending or torsion shown below can cause cracking in the Thermistors.



- Dividing/Breaking of the PC boards shall be done carefully at moderate speed by using a jig or apparatus to protect the Thermistors on the boards from mechanical damage.

- Examples of PCB dividing/breaking jigs:

The outline of PC board breaking jig is shown below. When PC boards are broken or divided, loading points should be close to the jig to minimize the extent of the bending

Also, planes with no parts mounted on should be used as plane of loading, in order to prevent tensile stress induced by the bending, which may cause cracks of the Thermistors or other parts mounted on the PC boards.

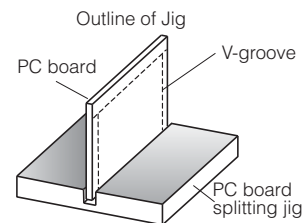

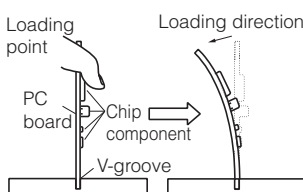
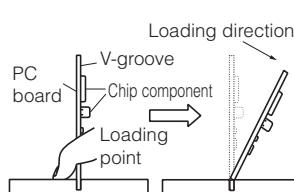
Prohibited dividing	Recommended dividing
	

## 9. Mechanical Impact

- The Thermistors shall be free from any excessive mechanical impact. The Thermistor body is made of ceramics and may be damaged or cracked if dropped. Never use a Thermistor which has been dropped; their quality may be impaired and failure rate increased.
- When handling PC boards with Thermistors mounted on them, do not allow the Thermistors to collide with another PC board. When mounted PC boards are handled or stored in a stacked state, the corner of a PC board might strike Thermistors, and the impact of the strike may cause damage or cracking and can deteriorate the withstand voltage and insulation resistance of the Thermistor.

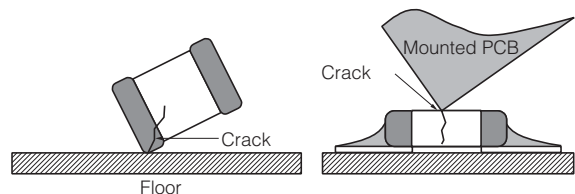

## Other

The various precautions described above are typical. For special mounting conditions, please contact us.



### Multilayer NTC Thermistors

Series: **ERTJ**

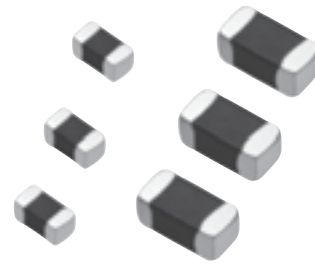

#### Features

- Surface Mount Device (0402, 0603)
- Highly reliable multilayer / monolithic structure
- Wide temperature operating range (-40 to 150 °C)
- Environmentally-friendly lead-free
- RoHS compliant

#### Recommended Applications

- For car audio system
- For ECUs
- For electric pumps and compressors
- For LED lights
- For batteries
- For temperature detection of various circuits

#### Explanation of Part Numbers

1		2		3		4		5		6		7		8		9		10		11		12	
E		R		T		J		0		E		G		1		0		3		F		M	

(Example)

Common Code		Size Code		Packaging Style Code	B Value Class Code		Nominal Resistance R <sub>25</sub> (Ω)	Resistance Tolerance Code														
Product Code	Type Code	0	"0402"		A	2701 to 2800		F	±1%	Narrow Tolerance Type												
ERT	NTC Thermistors	J	Chip Type (SMD) Multilayer Type	E	"0402" Pressed Carrier Taping Punched Carrier Taping (Pitch : 2 mm)	G	3301 to 3400	G	±2%													
				V	"0603" Punched Carrier Taping (Pitch : 4 mm)	M	3801 to 3900	H	±3%													
						P	4001 to 4100	J	±5%													
						R	4201 to 4300		Standard Type													
						S	4301 to 4400															
						T	4401 to 4500															
						V	4601 to 4700															
										M	Automotive component											

The first two digits are significant figures of resistance and the third one denotes the number of zeros following them.

#### Construction

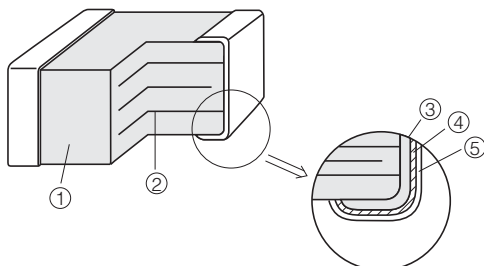

No.	Name	
①	Semiconductive Ceramics	
②	Internal electrode	
③	Terminal electrode	Substrate electrode
④		Intermediate electrode
⑤		External electrode

## Ratings

Size code (EIA)	0(0402)	1(0603)
Operating Temperature Range	-40 to 150 °C	
Rated Maximum Power Dissipation*1	66 mW	100 mW
Dissipation Factor*2	Approximately 2 mW/°C	Approximately 3 mW/°C

- \*1 Rated Maximum Power Dissipation : The maximum power that can be continuously applied at the rated ambient temperature.  
 · The maximum value of power, and rated power is same under the condition of ambient temperature 25 °C or less. If the temperature exceeds 25 °C, rated power depends on the decreased power dissipation curve.  
 · Please see "Operating Power" for details.
- \*2 Dissipation factor : The constant amount power required to raise the temperature of the Thermistor 1 °C through self heat generation under stable temperatures.  
 · Dissipation factor is the reference value when mounted on a glass epoxy board (1.6 mmT).

## Part Number List

### ● 0402(EIA)

Part Number	Nominal Resistance at 25 °C	B Value at 25/50(K)	B Value at 25/85(K)
ERTJ0EG103□M	10 kΩ	3380 K±1 %	3435 K±1 %
ERTJ0EP473□M	47 kΩ	4050 K±1 %	(4100 K)
ERTJ0ER104□M	100 kΩ	4250 K±1 %	(4300 K)
ERTJ0ET104□M	100 kΩ	4485 K±1 %	(4550 K)
ERTJ0EV104□M	100 kΩ	4700 K±1 %	(4750 K)
ERTJ0EV474□M	470 kΩ	4700 K±1 %	(4750 K)

□ : Resistance Tolerance Code (F : ±1%, G : ±2%, H : ±3%, J : ±5%)

### ● 0603(EIA)

Part Number	Nominal Resistance at 25 °C	B Value at 25/50(K)	B Value at 25/85(K)
ERTJ1VG103□M	10 kΩ	3380 K±1 %	3435 K±1 %
ERTJ1VP473□M	47 kΩ	4100 K±1 %	(4150 K)
ERTJ1VR104□M	100 kΩ	4200 K±1 %	(4250 K)
ERTJ1VV104□M	100 kΩ	4700 K±1 %	(4750 K)
ERTJ1VT224□M	220 kΩ	4485 K±1 %	(4550 K)

□ : Resistance Tolerance Code (F : ±1%, G : ±2%, H : ±3%, J : ±5%)

### ● Temperature and Resistance value (the resistance value at 25 °C is set to 1)/ Reference values

	ERTJ□□G~	ERTJ0EP~	ERTJ1VP~	ERTJ0ER~	ERTJ1VR~	ERTJ□□T~	ERTJ□□V~
B <sub>25/50</sub>	(3380 K)	4050 K	4100 K	4250 K	4200 K	4485 K	4700 K
B <sub>25/85</sub>	3435 K	(4100 K)	(4150 K)	(4300 K)	(4250 K)	(4550 K)	(4750 K)
T(°C)							
-40	20.52	33.10	34.56	42.40	40.49	46.47	59.76
-35	15.48	24.03	24.99	29.96	28.81	32.92	41.10
-30	11.79	17.63	18.26	21.42	20.72	23.55	28.61
-25	9.069	13.06	13.48	15.50	15.07	17.00	20.14
-20	7.037	9.761	10.04	11.33	11.06	12.38	14.33
-15	5.507	7.362	7.546	8.370	8.198	9.091	10.31
-10	4.344	5.599	5.720	6.244	6.129	6.729	7.482
-5	3.453	4.291	4.369	4.699	4.622	5.019	5.481
0	2.764	3.312	3.362	3.565	3.515	3.772	4.050
5	2.227	2.574	2.604	2.725	2.694	2.854	3.015
10	1.806	2.013	2.030	2.098	2.080	2.173	2.262
15	1.474	1.584	1.593	1.627	1.618	1.666	1.710
20	1.211	1.255	1.258	1.271	1.267	1.286	1.303
25	1	1	1	1	1	1	1
30	0.8309	0.8016	0.7994	0.7923	0.7944	0.7829	0.7734
35	0.6941	0.6461	0.6426	0.6318	0.6350	0.6168	0.6023
40	0.5828	0.5235	0.5194	0.5069	0.5108	0.4888	0.4721
45	0.4916	0.4266	0.4222	0.4090	0.4132	0.3896	0.3723
50	0.4165	0.3496	0.3451	0.3320	0.3363	0.3123	0.2954
55	0.3543	0.2881	0.2837	0.2709	0.2752	0.2516	0.2356
60	0.3027	0.2386	0.2344	0.2222	0.2263	0.2037	0.1889
65	0.2595	0.1985	0.1946	0.1831	0.1871	0.1658	0.1523
70	0.2233	0.1659	0.1623	0.1516	0.1554	0.1357	0.1236
75	0.1929	0.1393	0.1359	0.1261	0.1297	0.1117	0.1009
80	0.1672	0.1174	0.1143	0.1054	0.1087	0.09236	0.08284
85	0.1451	0.09937	0.09658	0.08843	0.09153	0.07675	0.06834
90	0.1261	0.08442	0.08189	0.07457	0.07738	0.06404	0.05662
95	0.1097	0.07200	0.06969	0.06316	0.06567	0.05366	0.04712
100	0.09563	0.06166	0.05957	0.05371	0.05596	0.04518	0.03939
105	0.08357	0.05306	0.05117	0.04585	0.04786	0.03825	0.03308
110	0.07317	0.04587	0.04415	0.03929	0.04108	0.03255	0.02791
115	0.06421	0.03979	0.03823	0.03378	0.03539	0.02781	0.02364
120	0.05650	0.03460	0.03319	0.02913	0.03059	0.02382	0.02009
125	0.04986	0.03013	0.02886	0.02519	0.02652	0.02043	0.01712

$$B_{25/50} = \frac{\ln(R_{25}/R_{50})}{1/298.15 - 1/323.15}$$

$$B_{25/85} = \frac{\ln(R_{25}/R_{85})}{1/298.15 - 1/358.15}$$

R<sub>25</sub>=Resistance at 25.0±0.1 °C  
 R<sub>50</sub>=Resistance at 50.0±0.1 °C  
 R<sub>85</sub>=Resistance at 85.0±0.1 °C

### Specification and Test Method

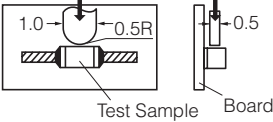
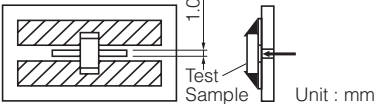
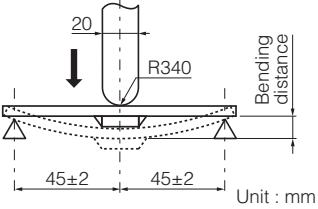
Item	Specification	Test Method									
Rated Zero-power Resistance (R <sub>25</sub> )	Within the specified tolerance.	The value is measured at a power that the influence of self-heat generation can be negligible (0.1mW or less), at the rated ambient temperature of 25.0±0.1°C.									
B Value	Shown in each Individual Specification. * Individual Specification shall specify B <sub>25/50</sub> or B <sub>25/85</sub> .	<p>The Zero-power resistances; R<sub>1</sub> and R<sub>2</sub>, shall be measured respectively at T<sub>1</sub> (deg.C) and T<sub>2</sub> (deg.C). The B value is calculated by the following equation.</p> $B_{T_1/T_2} = \frac{\ln(R_1) - \ln(R_2)}{1/(T_1 + 273.15) - 1/(T_2 + 273.15)}$ <table border="1"> <thead> <tr> <th></th> <th>T<sub>1</sub></th> <th>T<sub>2</sub></th> </tr> </thead> <tbody> <tr> <td>B<sub>25/50</sub></td> <td>25.0 ±0.1 °C</td> <td>50.0 ±0.1 °C</td> </tr> <tr> <td>B<sub>25/85</sub></td> <td>25.0 ±0.1 °C</td> <td>85.0 ±0.1 °C</td> </tr> </tbody> </table>		T <sub>1</sub>	T <sub>2</sub>	B <sub>25/50</sub>	25.0 ±0.1 °C	50.0 ±0.1 °C	B <sub>25/85</sub>	25.0 ±0.1 °C	85.0 ±0.1 °C
	T <sub>1</sub>	T <sub>2</sub>									
B <sub>25/50</sub>	25.0 ±0.1 °C	50.0 ±0.1 °C									
B <sub>25/85</sub>	25.0 ±0.1 °C	85.0 ±0.1 °C									
Adhesion	The terminal electrode shall be free from peeling or signs of peeling.	<p>Applied force : Size 0402, 0603 : 5 N Duration : 10 s</p> <p>Size : 0402</p>  <p>Size : 0603</p> 									
Bending Strength	There shall be no cracks and other mechanical damage. R <sub>25</sub> change : within ±5 %	<p>Bending distance : 2 mm Bending speed : 1 mm/s</p> 									
Resistance to Vibration	There shall be no cracks and other mechanical damage. R <sub>25</sub> change : within ±2 % B Value change : within ±1 %	<p>Solder samples on a testing substrate, then apply vibration to them.</p> <p>Acceleration : 5 G Vibrational frequency : 10 to 2000 Hz Sweep time : 20 minutes 12 cycles in three directions, which are perpendicular to each other</p>									
Resistance to Impact	There shall be no cracks and other mechanical damage. R <sub>25</sub> change : within ±2 % B Value change : within ±1 %	<p>Solder samples on a testing substrate, then apply impacts to them.</p> <p>Pulse waveform : Semisinusoidal wave, 11 ms Impact acceleration : 50 G Impact direction : X-X', Y-Y', Z-Z' In 6 directions, three times each</p>									

### Specification and Test Method

Item	Specification	Test Method							
Resistance to Soldering Heat	There shall be no cracks and other mechanical damage.  R <sub>25</sub> change : within ±2 % B Value change : within ±1 %	Soldering bath method Solder temperature : 260 ±5 °C, 270 ±5 °C Dipping period : 3.0 ±0.5 s, 10.0 ±0.5 s Preheat condition :							
		<table border="1"> <thead> <tr> <th>Step</th> <th>Temp (°C)</th> <th>Period (s)</th> </tr> </thead> <tbody> <tr> <td>1</td> <td>80 to 100</td> <td>120 to 180</td> </tr> <tr> <td>2</td> <td>150 to 200</td> <td>120 to 180</td> </tr> </tbody> </table>	Step	Temp (°C)	Period (s)	1	80 to 100	120 to 180	2
Step	Temp (°C)	Period (s)							
1	80 to 100	120 to 180							
2	150 to 200	120 to 180							
Solderability	More than 95 % of the soldered area of both terminal electrodes shall be covered with fresh solder.	Soldering bath method Solder temperature : 230 ±5 °C Dipping period : 4 ±1 s Solder : Sn-3.0Ag-0.5Cu							
Temperature Cycling	R <sub>25</sub> change : within ±2 % B Value change : within ±1 %	Conditions of one cycle Step 1 : -55±3 °C, 30±3 min. Step 2 : Room temp., 3 min. max. Step 3 : 125±5 °C, 30±3 min. Step 4 : Room temp., 3 min. max. Number of cycles: 2000 cycles							
Humidity	R <sub>25</sub> change : within ±2 % B Value change : within ±1 %	Temperature : 85 ±2 °C Relative humidity : 85 ±5 % Test period : 2000 +48/0 h							
Biased Humidity	R <sub>25</sub> change : within ±2 % B Value change : within ±1 %	Temperature : 85 ±2 °C Relative humidity : 85 ±5 % Applied power : 10 mW(D.C.) Test period : 2000 +48/0 h							
Low Temperature Exposure	R <sub>25</sub> change : within ±2 % B Value change : within ±1 %	Temperature : -40 ±3 °C Test period : 2000 +48/0 h							
High Temperature Exposure 1	R <sub>25</sub> change : within ±2 % B Value change : within ±1 %	Temperature : 125 ±3 °C Test period : 2000 +48/0 h							
High Temperature Exposure 2	R <sub>25</sub> change : within ±3 % B Value change : within ±2 %	Temperature : 150 ±3 °C Test period : 1000 +48/0 h							

### Dimensions in mm (not to scale)

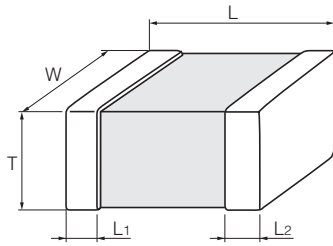

Size Code (EIA)	L	W	T	L <sub>1</sub> , L <sub>2</sub>
0 (0402)	1.0±0.1	0.50±0.05	0.50±0.05	0.25±0.15
1 (0603)	1.60±0.15	0.8±0.1	0.8±0.1	0.3±0.2

(Unit: mm)

### Packaging Methods

#### ● Standard Packing Quantities

Size Code	Thickness (mm)	Kind of Taping	Pitch (mm)	Quantity (pcs./reel)
0 (0402)	0.5	Punched Carrier Taping	2	10,000
1 (0603)	0.8		4	4,000

#### ● Reel for Taping

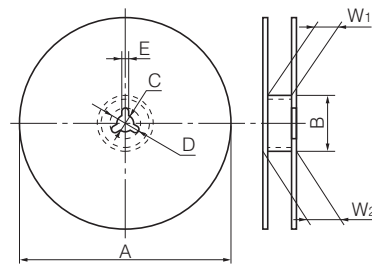

Symbol	φA	φB	C	D	E	W <sub>1</sub>	W <sub>2</sub>
Dim. (mm)	180 <sup>-0.3</sup>	60.0 <sup>+1.0</sup> <sub>0</sub>	13.0±0.5	21.0±0.8	2.0±0.5	9.0 <sup>+1.0</sup> <sub>0</sub>	11.4±1.0

#### ● Pitch 2 mm (Punched Carrier Taping) : Size 0402

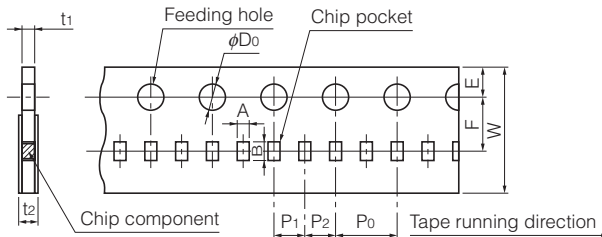

Symbol	A	B	W	F	E	P <sub>1</sub>	P <sub>2</sub>	P <sub>0</sub>	φD <sub>0</sub>	t <sub>1</sub>	t <sub>2</sub>
Dim. (mm)	0.62 ±0.05	1.12 ±0.05	8.0 ±0.2	3.50 ±0.05	1.75 ±0.10	2.00 ±0.05	2.00 ±0.05	4.0 ±0.1	1.5 <sup>+0.1</sup> <sub>0</sub>	0.7 max.	1.0 max.

#### ● Pitch 4 mm (Punched Carrier Taping) : Size 0603

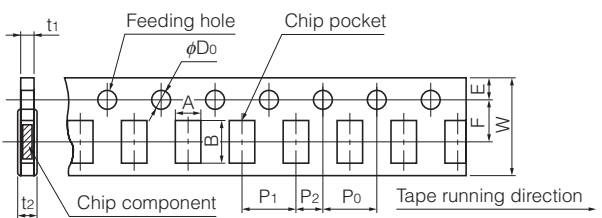

Symbol	A	B	W	F	E	P <sub>1</sub>	P <sub>2</sub>	P <sub>0</sub>	φD <sub>0</sub>	t <sub>1</sub>	t <sub>2</sub>
Dim. (mm)	1.0 ±0.1	1.8 ±0.1	8.0 ±0.2	3.50 ±0.05	1.75 ±0.10	4.0 ±0.1	2.00 ±0.05	4.0 ±0.1	1.5 <sup>+0.1</sup> <sub>0</sub>	1.1 max.	1.4 max.

#### ● Leader Part and Taped End

##### Leader part

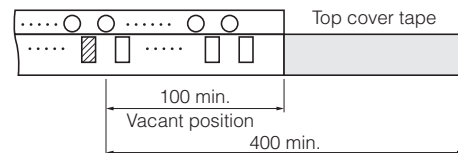

##### Taped end

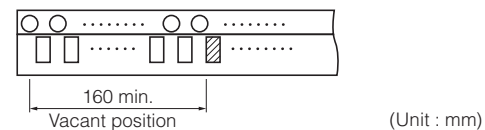

### Minimum Quantity / Packing Unit

Part Number (Size)	Minimum Quantity/ Packing Unit	Packing Quantity in Carton	Carton L×W×H (mm)
ERTJ0 (0402)	10,000	200,000	250×200×200
ERTJ1 (0603)	4,000	80,000	250×200×200

Part No., quantity and country of origin are designated on outer packages in English.

**Multilayer NTC Thermistors**

Series: **ERTJ**

**Handling Precautions**

**⚠ Safety Precautions**

The NTC Thermistors for automotive devices (chip type), hereafter referred to as Thermistors, is designed for use in automotive devices. When subjected to severe electrical, environmental, and/or mechanical stress beyond the specifications, as noted in the Ratings and Specified Conditions section, the Thermistors' performance may be degraded, or become failure mode, such as short circuit mode and open-circuit mode. If you use under the condition of short-circuit, heat generation of thermistors will occur by running large current due to application of voltage. There are possibilities of smoke emission, substrate burn-out, and, in the worst case, fire.

For products which require higher safety levels, please carefully consider how a single malfunction can affect your product. In order to ensure the safety in the case of a single malfunction, please design products with fail-safe, such as setting up protecting circuits, etc.

- For the following applications and conditions, please contact us for product of special specification not found in this document.
  - When your application may have difficulty complying with the safety or handling precautions specified below.
  - High-quality and high-reliability required devices that have possibility of causing hazardous conditions, such as death or injury (regardless of directly or indirectly), due to failure or malfunction of the product.
    - ① Aircraft and Aerospace Equipment (artificial satellite, rocket, etc.)
    - ② Submarine Equipment (submarine repeating equipment, etc.)
    - ③ Transportation Equipment (airplanes, trains, ship, traffic signal controllers, etc.)
    - ④ Power Generation Control Equipment (atomic power, hydroelectric power, thermal power plant control system, etc.)
    - ⑤ Medical Equipment (life-support equipment, pacemakers, dialysis controllers, etc.)
    - ⑥ Information Processing Equipment (large scale computer systems, etc.)
    - ⑦ Electric Heating Appliances, Combustion devices (gas fan heaters, oil fan heaters, etc.)
    - ⑧ Rotary Motion Equipment
    - ⑨ Security Systems
    - ⑩ And any similar types of equipment

**Operating Conditions and Circuit Design**

**1. Circuit Design**

**1.1 Operating Temperature and Storage Temperature**

When operating a components-mounted circuit, please be sure to observe the "Operating Temperature Range", written in delivery specifications. Please remember not to use the product under the condition that exceeds the specified maximum temperature.

Storage temperature of PCB after mounting Thermistors, which is not operated, should be within the specified "Storage Temperature Range" in the delivery specifications.

**1.2 Operating Power**

The electricity applied to between terminals of Thermistors should be under the specified maximum power dissipation.

There are possibilities of breakage and burn-out due to excessive self-heating of Thermistors, if the power exceeds maximum power dissipation when operating. Please consider installing protection circuit for your circuit to improve the safety, in case of abnormal voltage application and so on.

Thermistors' performance of temperature detection would be deteriorated if self-heating occurs, even when you use it under the maximum power dissipation.

Please consider the maximum power dissipation and dissipation factor.

**[Maximum power dissipation]**

· The Maximum power that can be continuously applied under static air at a certain ambient temperature. The Maximum power dissipation under an ambient temperature of 25 °C or less is the same with the rated maximum power dissipation, and Maximum power dissipation beyond 25 °C depends on the Decreased power dissipation curve below.

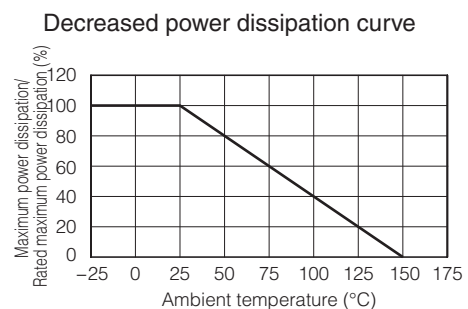

**[Dissipation factor]**

· The constant amount power required to raise the temperature of the Thermistor 1 °C through self heat generation under stable temperatures.  
 Dissipation factor (mW/°C) = Power consumption of Thermistor / Temperature rise of element

### 1.3 Environmental Restrictions

The Thermistors shall not be operated and/or stored under the following conditions.

- (1) Environmental conditions
  - (a) Under direct exposure to water or salt water
  - (b) Under conditions where water can condense and/or dew can form
  - (c) Under conditions containing corrosive gases such as hydrogen sulfide, sulfurous acid, chlorine and ammonia
- (2) Mechanical conditions
 

The place where vibration or impact that exceeds specified conditions written in delivery specification is loaded.

### 1.4 Measurement of Resistance

The resistance of the Thermistors varies depending on ambient temperatures and self-heating. To measure the resistance value when examining circuit configuration and conducting receiving inspection and so on, the following points should be taken into consideration:

- ① Measurement temp :  $25 \pm 0.1$  °C  
Measurement in liquid (silicon oil, etc.) is recommended for a stable measurement temperature.
- ② Power : 0.10 mW max.  
4 terminal measurement with a constant-current power supply is recommended.

## 2. Design of Printed Circuit Board

### 2.1 Selection of Printed Circuit Boards

There is a possibility of performance deterioration by heat shock (temperature cycles), which causes cracks, from alumina substrate.

Please confirm that the substrate you use does not deteriorate the Thermistors' quality.

### 2.2 Design of Land Pattern

- (1) Recommended land dimensions are shown below. Use the proper amount of solder in order to prevent cracking. Using too much solder places excessive stress on the Thermistors.

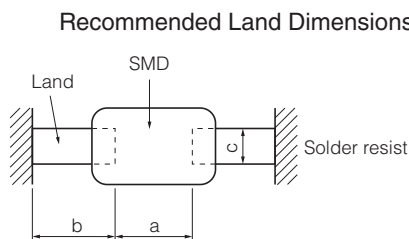

Unit (mm)

Size Code (EIA)	Component dimensions			a	b	c
	L	W	T			
0(0402)	1.0	0.5	0.5	0.4 to 0.5	0.4 to 0.5	0.4 to 0.5
1(0603)	1.6	0.8	0.8	0.8 to 1.0	0.6 to 0.8	0.6 to 0.8

- (2) The land size shall be designed to have equal space, on both right and left sides. If the amount of solder on both sides is not equal, the component may be cracked by stress, since the side with a larger amount of solder solidifies later during cooling.

### Recommended Amount of Solder

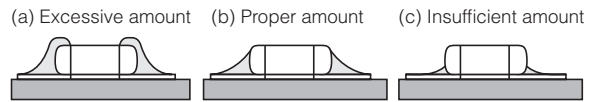

### 2.3 Utilization of Solder Resist

- (1) Solder resist shall be utilized to equalize the amounts of solder on both sides.
- (2) Solder resist shall be used to divide the pattern for the following cases;
  - Components are arranged closely.
  - The Thermistor is mounted near a component with lead wires.
  - The Thermistor is placed near a chassis.
 Refer to the table below.

### Prohibited Applications and Recommended Applications

Item	Prohibited applications	Improved applications by pattern division
Mixed mounting with a component with lead wires	The lead wire of a component with lead wires	Solder resist
Arrangement near chassis	Chassis Solder (Ground solder) Electrode pattern	Solder resist
Retro-fitting of component with lead wires	Soldering iron A lead wire of Retro-fitted component	Solder resist
Lateral arrangement	Portion to be excessively soldered Land	Solder resist

### 2.4 Component Layout

To prevent the crack of Thermistors, try to place it on the position that could not easily be affected by the bending stress of substrate while mounting procedures or procedures afterwards.

Placement of the Thermistors near heating elements also requires the great care to be taken in order to avoid stresses from rapid heating and cooling.

- (1) To minimize mechanical stress caused by the warp or bending of a PC board, please follow the recommended Thermistors' layout below.

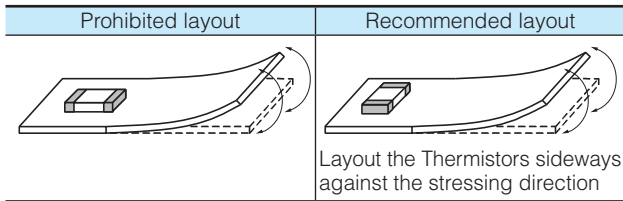

- (2) The following layout is for your reference since mechanical stress near the dividing/breaking position of a PC board varies depending on the mounting position of the Thermistors.

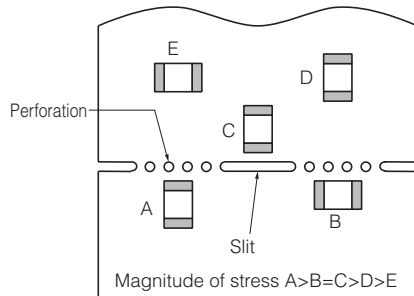

- (3) The magnitude of mechanical stress applied to the Thermistors when dividing the circuit board in descending order is as follows:  
 push back < slit < V-groove < perforation.  
 Also take into account the layout of the Thermistors and the dividing/breaking method.
- (4) When the Thermistors are placed near heating elements such as heater, etc., cracks from thermal stresses may occur under following situation:
- Soldering the Thermistors directly to heating elements.
  - Sharing the land with heating elements.
- If planning to conduct above-mentioned mounting and/or placement, please contact us in advance.

### 2.5 Mounting Density and Spaces

Intervals between components should not be too narrow to prevent the influence from solder bridges and solder balls. The space between components should be carefully determined.

## Precautions for Assembly

### 1. Storage



- (1) The Thermistors shall be stored between 5 to 40 °C and 20 to 70 % RH, not under severe conditions of high temperature and humidity.
- (2) If stored in a place where humidity, dust, or corrosive gasses (hydrogen sulfide, sulfurous acid, hydrogen chloride and ammonia, etc.) are contained, the solderability of terminal electrodes will be deteriorated.  
 In addition, storage in a places where the heat or direct sunlight exposure occur will cause mounting problems due to deformation of tapes and reels and components and taping/reels sticking together.
- (3) Do not store components longer than 6 months. Check the solderability of products that have been stored for more than 6 months before use

### 2. Chip Mounting Consideration

- (1) When mounting the Thermistors/components on a PC board, the Thermistor bodies shall be free from excessive impact loads such as mechanical impact or stress due to the positioning, pushing force and displacement of vacuum nozzles during mounting.
- (2) Maintenance and inspection of the Chip Mounter must be performed regularly.
- (3) If the bottom dead center of the vacuum nozzle is too low, the Thermistor will crack from excessive force during mounting.

The following precautions and recommendations are for your reference in use.

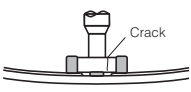
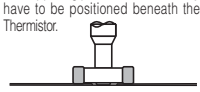
- (a) Set and adjust the bottom dead center of the vacuum nozzles to the upper surface of the PC board after correcting the warp of the PC board.
- (b) Set the pushing force of the vacuum nozzle during mounting to 1 to 3 N in static load.
- (c) For double surface mounting, apply a supporting pin on the rear surface of the PC board to suppress the bending of the PC board in order to minimize the impact of the vacuum nozzles. Typical examples are shown in the table below.

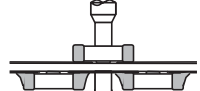
Item	Prohibited mounting	Recommended mounting
Single surface mounting		 The supporting pin does not necessarily have to be positioned beneath the Thermistor.
Double surface mounting		

- (d) Adjust the vacuum nozzles so that their bottom dead center during mounting is not too low.
- (4) The closing dimensions of the positioning chucks shall be controlled. Maintenance and replacement of positioning chucks shall be performed regularly to prevent chipping or cracking of the Thermistors caused by mechanical impact during positioning due to worn positioning chucks.
  - (5) Maximum stroke of the nozzle shall be adjusted so that the maximum bending of PC board does not exceed 0.5 mm at 90 mm span. The PC board shall be supported by an adequate number of supporting pins.

### 3. Selection of Soldering Flux

Soldering flux may seriously affect the performance of the Thermistors. The following shall be confirmed before use.

- (1) The soldering flux should have a halogen based content of 0.1 wt% (converted to chlorine) or below. Do not use soldering flux with strong acid.
- (2) When applying water-soluble soldering flux, wash the Thermistors sufficiently because the soldering flux residue on the surface of PC boards may deteriorate the insulation resistance on the Thermistors' surface.



## 4. Soldering

### 4.1 Reflow Soldering

The reflow soldering temperature conditions are composed of temperature curves of Preheating, Temp. rise, Heating, Peak and Gradual cooling. Large temperature difference inside the Thermistors caused by rapid heat application to the Thermistors may lead to excessive thermal stresses, contributing to the thermal cracks. The Preheating temperature requires controlling with great care so that tombstone phenomenon may be prevented.

Item	Temperature	Period or Speed
①Preheating	140 to 180 °C	60 to 120 sec
②Temp. rise	Preheating temp to Peak temp.	2 to 5 °C /sec
③Heating	220 °C min.	60 sec max.
④Peak	260 °C max.	10 sec max.
⑤Gradual cooling	Peak temp. to 140 °C	1 to 4 °C /sec

#### Recommended profile of Reflow soldering (EX)

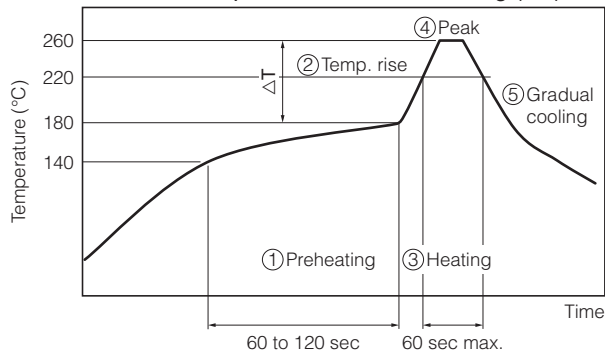

$\Delta T$  : Allowable temperature difference  $\Delta T \leq 150 \text{ }^\circ\text{C}$

The rapid cooling (forced cooling) during Gradual cooling part should be avoided, because this may cause defects such as the thermal cracks, etc. When the Thermistors are immersed into a cleaning solvent, make sure that the surface temperatures of the devices do not exceed 100 °C. Performing reflow soldering twice under the conditions shown in the figure above [Recommended profile of Reflow soldering (EX)] will not cause any problems. However, pay attention to the possible warp and bending of the PC board.

### 4.2 Hand Soldering

Hand soldering typically causes significant temperature change, which may induce excessive thermal stresses inside the Thermistors, resulting in the thermal cracks, etc. In order to prevent any defects, the following should be observed.

- The temperature of the soldering tips should be controlled with special care.
- The direct contact of soldering tips with the Thermistors and/or terminal electrodes should be avoided.
- Dismounted Thermistors shall not be reused.

#### (1) Condition 1 (with preheating)

##### (a) Soldering:

Use thread solder ( $\phi 1$  mm or below) which contains flux with low chlorine, developed for precision electronic equipment.

#### (b) Preheating:

Conduct sufficient pre-heating, and make sure that the temperature difference between solder and Thermistors' surface is 150 °C or less.

#### (c) Temperature of Iron tip: 300 °C max.

(The required amount of solder shall be melted in advance on the soldering tip.)

#### (d) Gradual cooling:

After soldering, the Thermistors shall be cooled gradually at room temperature.

#### Recommended profile of Hand soldering (EX)

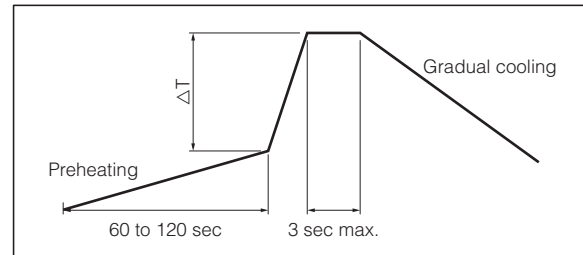

$\Delta T$  : Allowable temperature difference  $\Delta T \leq 150 \text{ }^\circ\text{C}$

#### (2) Condition 2 (without preheating)

Hand soldering can be performed without preheating, by following the conditions below:

- (a) Soldering iron tip shall never directly touch the ceramic and terminal electrodes of the Thermistors.
- (b) The lands are sufficiently preheated with a soldering iron tip before sliding the soldering iron tip to the terminal electrodes of the Thermistors for soldering.

#### Conditions of Hand soldering without preheating

Item	Condition
Temperature of Iron tip	270 °C max.
Wattage	20 W max.
Shape of Iron tip	$\phi 3$ mm max.
Soldering time with a soldering iron	3 sec max.

## 5. Post Soldering Cleaning

### 5.1 Cleaning solvent

Soldering flux residue may remain on the PC board if cleaned with an inappropriate solvent. This may deteriorate the electrical characteristics and reliability of the Thermistors.

### 5.2 Cleaning conditions

Inappropriate cleaning conditions such as insufficient cleaning or excessive cleaning may impair the electrical characteristics and reliability of the Thermistors.

#### (1) Insufficient cleaning can lead to:

- (a) The halogen substance found in the residue of the soldering flux may cause the metal of terminal electrodes to corrode.
- (b) The halogen substance found in the residue of the soldering flux on the surface of the Thermistors may change resistance values.
- (c) Water-soluble soldering flux may have more remarkable tendencies of (a) and (b) above compared to those of rosin soldering flux.

- (2) Excessive cleaning can lead to:
- (a) When using ultrasonic cleaner, make sure that the output is not too large, so that the substrate will not resonate. The resonance causes the cracks in Varistors and/or solders, and deteriorates the strength of the terminal electrodes. Please follow these conditions for Ultrasonic cleaning:
    - Ultrasonic wave output : 20 W/L max.
    - Ultrasonic wave frequency : 40 kHz max.
    - Ultrasonic wave cleaning time : 5 min. max.

### 5.3 Contamination of Cleaning solvent

Cleaning with contaminated cleaning solvent may cause the same results as insufficient cleaning due to the high density of liberated halogen.

## 6. Inspection Process

The pressure from measuring terminal pins might bend the PCB when implementing circuit inspection after mounting Thermistors on PCB, and as a result, cracking may occur.

- (1) Mounted PC boards shall be supported by an adequate number of supporting pins on the back with bend settings of 90 mm span 0.5 mm max.
- (2) Confirm that the measuring pins have the right tip shape, are equal in height, have the right tip pressure, and are set in the correct positions. The following figures are for your reference to avoid bending the PC board.

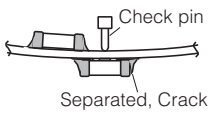
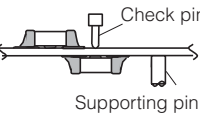
Item	Prohibited setting	Recommended setting
Bending of PC board	 <p>Separated, Crack</p>	 <p>Supporting pin</p>

## 7. Protective Coating

When the surface of a PC board on which the Thermistors have been mounted is coated with resin to protect against moisture and dust, it shall be confirmed that the protective coating does not affect the performance of Varistors.

- (1) Choose the material that does not emit the decomposition and/or reaction gas. The Gas may affect the composing members of the Varistors.
- (2) Shrinkage and expansion of resin coating when curing may apply stress to the Varistors and may lead to occurrence of cracks.

## 8. Dividing/Breaking of PC Boards

- (1) Please be careful not to stress the substrate with bending/twisting when dividing, after mounting components including Varistors. Abnormal and excessive mechanical stress such as bending or torsion shown below can cause cracking in the Thermistors.

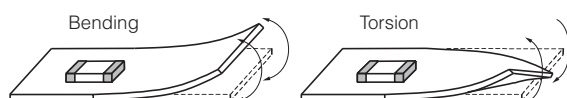

- (2) Dividing/Breaking of the PC boards shall be done carefully at moderate speed by using a jig or apparatus to protect the Thermistors on the boards from mechanical damage.
- (3) Examples of PCB dividing/breaking jigs:
 

The outline of PC board breaking jig is shown below. When PC boards are broken or divided, loading points should be close to the jig to minimize the extent of the bending

Also, planes with no parts mounted on should be used as plane of loading, in order to prevent tensile stress induced by the bending, which may cause cracks of the Thermistors or other parts mounted on the PC boards.

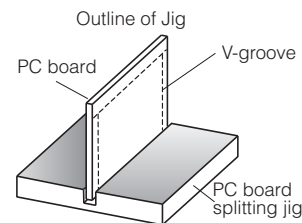

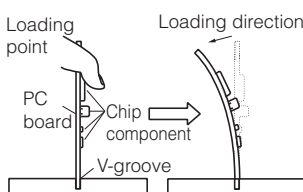
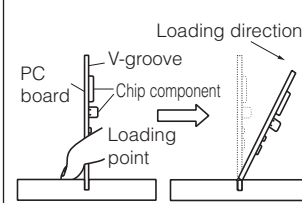
Prohibited dividing	Recommended dividing
	

## 9. Mechanical Impact

- (1) The Thermistors shall be free from any excessive mechanical impact. The Thermistor body is made of ceramics and may be damaged or cracked if dropped. Never use a Thermistor which has been dropped; their quality may be impaired and failure rate increased.
- (2) When handling PC boards with Thermistors mounted on them, do not allow the Thermistors to collide with another PC board. When mounted PC boards are handled or stored in a stacked state, the corner of a PC board might strike Thermistors, and the impact of the strike may cause damage or cracking and can deteriorate the withstand voltage and insulation resistance of the Thermistor.

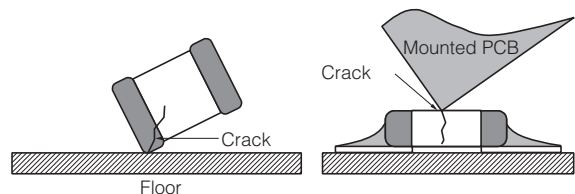

## Other

The various precautions described above are typical. For special mounting conditions, please contact us.

## “PGS” Graphite Sheets

Type: **EYG**

“PGS (Pyrolytic Graphite Sheet)” is a thermal interface material which is very thin, synthetically made, has high thermal conductivity, and is made from a highly oriented graphite polymer film. It is ideal for providing thermal management/heat-sinking in limited spaces or to provide supplemental heat-sinking in addition to conventional means. This material is flexible and can be cut into customizable shapes.

“SSM(Semi-Sealing Material)” is the product which is compounding PGS Graphite sheet and High thermal conductive Elastomer resin. It has a function to absorb heat by resin and release the heat by utilizing high thermal conductivity of PGS Graphite sheet. It also enables taking better attachment to the component which has different height on the electronic board, reducing stress to the electronic board.

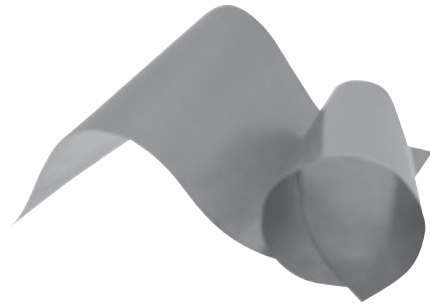

### Features

- Excellent thermal conductivity : 700 to 1950 W/(m·K)  
(2 to 5 times as high as copper, 3 to 8 times as high as aluminum)
- Lightweight: Specific gravity : 0.85 to 2.13 g/cm<sup>3</sup>  
(1/4 to 1/10 of copper, 1/1.3 to 1/3 of aluminum in density)
- Flexible and easy to be cut or trimmed. (withstands repeated bending)
- Low thermal resistance
- Low heat resistance with flexible Graphite sheet (SSM)
- Low repulsion and easy to keep the product's shape after attaching (SSM)
- Siloxane Free(SSM)
- High dielectric voltage : 17 kVac/mm (SSM)
- RoHS compliant

### Recommended applications

- Smart phones, Mobile phones, DSC, DVC, Tablet PCs, PCs and peripherals, LED Devices
- Semiconductor manufacturing equipment (Sputtering, Dry etching, Steppers)
- Optical communications equipment

## Explanation of Part Numbers

### ● PGS only (EYGS\*\*\*\*\*)

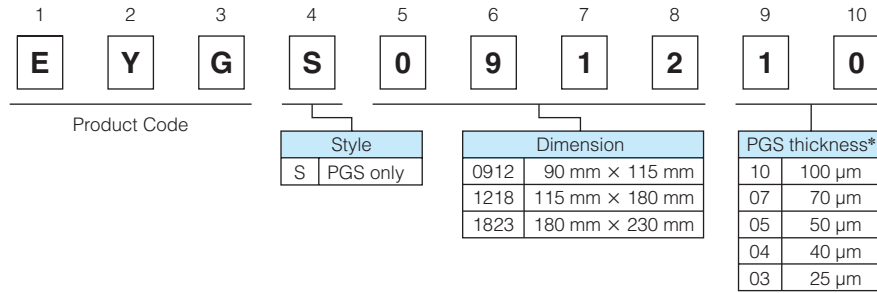

\* PGS thickness of 17 μm, 10 μm does not support as single item.

### ● Taping (EYGA\*\*\*\*\*)

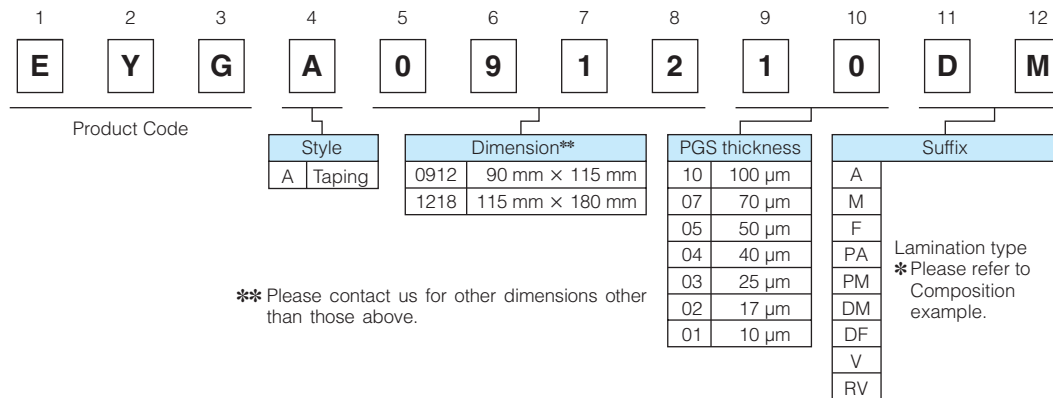

\*\* Please contact us for other dimensions other than those above.

### ● Thermally conductive elastomer processing (EYGE\*\*\*\*\*)

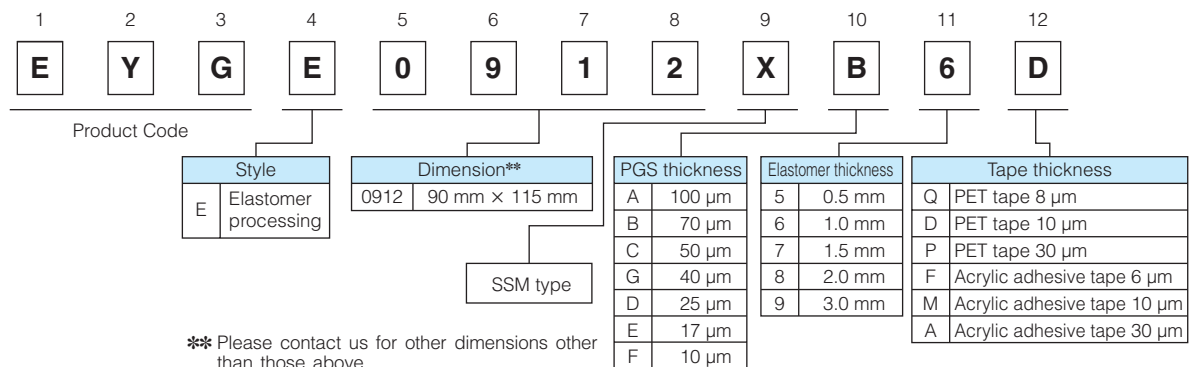

\*\* Please contact us for other dimensions other than those above.

## Characteristics of PGS Graphite Sheets

Thickness		100 μm	70 μm	50 μm	40 μm
		0.10±0.03 mm	0.07±0.015 mm	0.050±0.015 mm	0.040±0.012 mm
Density		0.85 g/cm <sup>3</sup>	1.21 g/cm <sup>3</sup>	1.70 g/cm <sup>3</sup>	1.80 g/cm <sup>3</sup>
Thermal conductivity	a-b plane	700 W/(m·K)	1000 W/(m·K)	1300 W/(m·K)	1350 W/(m·K)
Electrical conductivity		10000 S/cm	10000 S/cm	10000 S/cm	10000 S/cm
Extensional strength		20.0 MPa	20.0 MPa	20.0 MPa	25.0 MPa
Expansion coefficient	a-b plane	9.3×10 <sup>-7</sup> 1/K	9.3×10 <sup>-7</sup> 1/K	9.3×10 <sup>-7</sup> 1/K	9.3×10 <sup>-7</sup> 1/K
	c axis	3.2×10 <sup>-5</sup> 1/K	3.2×10 <sup>-5</sup> 1/K	3.2×10 <sup>-5</sup> 1/K	3.2×10 <sup>-5</sup> 1/K
Heat resistance*		400 °C			
Bending(angle 180,R5)		10000 cycles			

Thickness		25 μm	17 μm	10 μm
		0.025±0.010 mm	0.017±0.005 mm	0.010±0.002 mm
Density		1.90 g/cm <sup>3</sup>	2.10 g/cm <sup>3</sup>	2.13 g/cm <sup>3</sup>
Thermal conductivity	a-b plane	1600 W/(m·K)	1850 W/(m·K)	1950 W/(m·K)
Electrical conductivity		20000 S/cm	20000 S/cm	20000 S/cm
Extensional strength		30.0 MPa	40.0 MPa	40.0 MPa
Expansion coefficient	a-b plane	9.3×10 <sup>-7</sup> 1/K	9.3×10 <sup>-7</sup> 1/K	9.3×10 <sup>-7</sup> 1/K
	c axis	3.2×10 <sup>-5</sup> 1/K	3.2×10 <sup>-5</sup> 1/K	3.2×10 <sup>-5</sup> 1/K
Heat resistance*		400 °C		
Bending(angle 180,R5)		10000 cycles		

\* Withstand temperature refers to PGS only.  
(Lamination material such as PET tape etc. is not included)

\*\* Values are for reference, not guaranteed.

## Characteristics of SSM (Elastomer)

Thickness		1 mm	2 mm	3 mm
Specific heat		1.4 J/(g·C)		
Density		1.88 g/cm <sup>3</sup>		
Thermal conductivity		1.6 W/(m·K)**		
Thermal resistance	100 kPa	7.53 (C·cm <sup>2</sup> )/W	14.82 (C·cm <sup>2</sup> )/W	19.48 (C·cm <sup>2</sup> )/W
	200 kPa	6.71 (C·cm <sup>2</sup> )/W	13.17 (C·cm <sup>2</sup> )/W	16.01 (C·cm <sup>2</sup> )/W
	300 kPa	5.90 (C·cm <sup>2</sup> )/W	10.73 (C·cm <sup>2</sup> )/W	11.38 (C·cm <sup>2</sup> )/W
Compressibility	100 kPa	4.93 %	4.05 %	4.43 %
	200 kPa	9.58 %	8.66 %	14.04 %
	300 kPa	18.41 %	22.13 %	40.49 %
Resistivity		> 10×10 <sup>14</sup> Ω·cm		
Dielectric voltage		> 17 kVac/mm		
Hardness (Type E)		39		
Adhesive force	SUS	39 mN/cm		
	Aluminum	31 mN/cm		
	Glass	38 mN/cm		

\* Characteristics refer to Elastomer resin only.

\*\* Typical values, not guaranteed.

## Comparison of thermal conductivity (a-b plane)

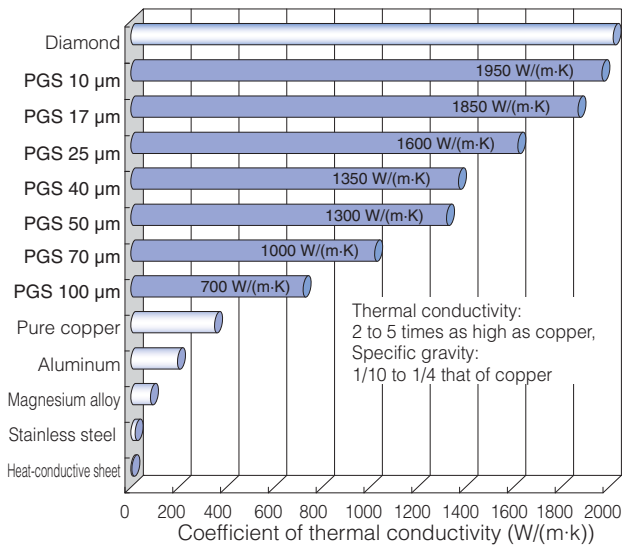

## Layered structure of PGS

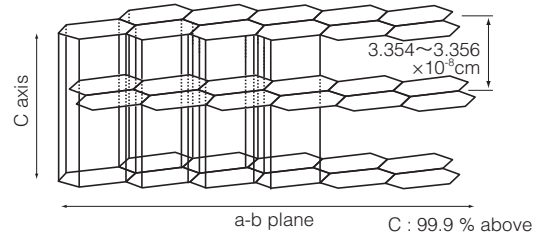

## Electric field shield performance

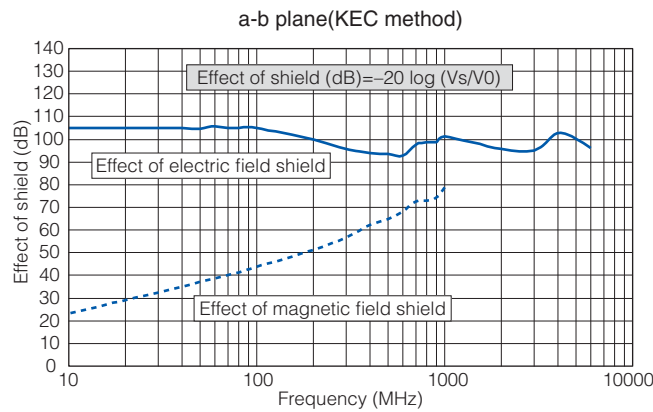

## Lamination type/Composition example

- Standard series ( PGS 100, 70, 50, 40, 25, 17, 10 μm)

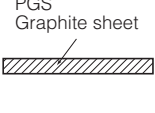
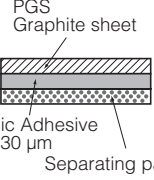
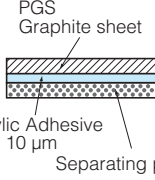
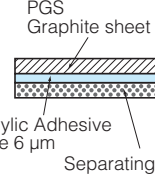
Type	Adhesive Type				
	PGS Only S type	A-A type	A -M type	A -F type	
Front face	–	–	–	–	
Rear face	–	Insulative adhesion type 30 μm	Insulative thin adhesion type 10 μm	Insulative thin adhesion type 6 μm	
Structure					
Features	<ul style="list-style-type: none"> <li>· High Thermal Conductivity</li> <li>· High Flexibility</li> <li>· Low Thermal Resistance</li> <li>· Available up to 400 °C</li> <li>· Conductive Material</li> </ul>	<ul style="list-style-type: none"> <li>· With insulation material on one side</li> <li>· With strong adhesive tape for putting chassis</li> <li>· Withstanding Voltage : 2 kV</li> </ul>	<ul style="list-style-type: none"> <li>· With insulation material on one side</li> <li>· Low thermal resistance comparison with A-A type</li> <li>· Withstanding Voltage : 1 kV</li> </ul>	<ul style="list-style-type: none"> <li>· With insulation material on one side</li> <li>· Low thermal resistance comparison with A-A type</li> </ul>	
Withstand temperature	400 °C	100 °C	100 °C	100 °C	
Standard size	115 × 180 mm	90 × 115 mm	90 × 115 mm	90 × 115 mm	
Maximum size	180 × 230 mm (25 μm to)	115 × 180 mm	115 × 180 mm	115 × 180 mm	
100 μm	Part No.	EYGS121810	EYGA091210A	EYGA091210M	EYGA091210F
	Thickness	100 μm	130 μm	110 μm	106 μm
70 μm	Part No.	EYGS121807	EYGA091207A	EYGA091207M	EYGA091207F
	Thickness	70 μm	100 μm	80 μm	76 μm
50 μm	Part No.	EYGS121805	EYGA091205A	EYGA091205M	EYGA091205F
	Thickness	50 μm	80 μm	60 μm	56 μm
40 μm	Part No.	EYGS121804	EYGA091204A	EYGA091204M	EYGA091204F
	Thickness	40 μm	70 μm	50 μm	46 μm
25 μm	Part No.	EYGS121803	EYGA091203A	EYGA091203M	EYGA091203F
	Thickness	25 μm	55 μm	35 μm	31 μm
17 μm	Part No.	–	EYGA091202A	EYGA091202M	EYGA091202F
	Thickness	–	47 μm	27 μm	23 μm
10 μm	Part No.	–	EYGA091201A	EYGA091201M	EYGA091201F
	Thickness	–	40 μm	20 μm	16 μm

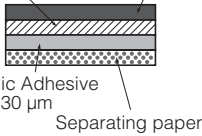
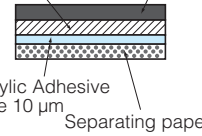
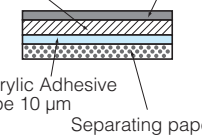
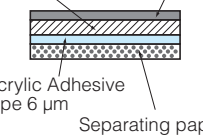
Type	Laminated type (Insulation & Adhesive)				
	A-PA type	A-PM type	A-DM type	A-DF type	
Front face	Polyester tape standard type 30 μm	Polyester tape standard type 30 μm	Polyester tape thin type 10 μm	Polyester tape thin type 10 μm	
Rear face	Insulative adhesion type 30 μm	Insulative thin adhesion type 10 μm	Insulative thin adhesion type 10 μm	Insulative thin adhesion type 6 μm	
Structure					
Features	<ul style="list-style-type: none"> <li>· With insulation material on both side</li> <li>· Withstanding Voltage PET tape : 4 kV</li> <li>· Adhesive Tape : 2 kV</li> </ul>	<ul style="list-style-type: none"> <li>· With insulation material on both side</li> <li>· Withstanding Voltage PET tape : 4 kV</li> <li>· Adhesive Tape : 1 kV</li> </ul>	<ul style="list-style-type: none"> <li>· With insulation material on both side</li> <li>· Withstanding Voltage PET tape : 1 kV</li> <li>· Adhesive Tape : 1 kV</li> </ul>	<ul style="list-style-type: none"> <li>· With insulation material on both side</li> <li>· Withstanding Voltage PET tape : 1 kV</li> </ul>	
Withstand temperature	100 °C	100 °C	100 °C	100 °C	
Standard size	90 × 115 mm	90 × 115 mm	90 × 115 mm	90 × 115 mm	
Maximum size	115 × 180 mm	115 × 180 mm	115 × 180 mm	115 × 180 mm	
100 μm	Part No.	EYGA091210PA	EYGA091210PM	EYGA091210DM	EYGA091210DF
	Thickness	160 μm	140 μm	120 μm	116 μm
70 μm	Part No.	EYGA091207PA	EYGA091207PM	EYGA091207DM	EYGA091207DF
	Thickness	130 μm	110 μm	90 μm	86 μm
50 μm	Part No.	EYGA091205PA	EYGA091205PM	EYGA091205DM	EYGA091205DF
	Thickness	110 μm	90 μm	70 μm	66 μm
40 μm	Part No.	EYGA091204PA	EYGA091204PM	EYGA091204DM	EYGA091204DF
	Thickness	100 μm	80 μm	60 μm	56 μm
25 μm	Part No.	EYGA091203PA	EYGA091203PM	EYGA091203DM	EYGA091203DF
	Thickness	85 μm	65 μm	45 μm	41 μm
17 μm	Part No.	EYGA091202PA	EYGA091202PM	EYGA091202DM	EYGA091202DF
	Thickness	77 μm	57 μm	37 μm	33 μm
10 μm	Part No.	EYGA091201PA	EYGA091201PM	EYGA091201DM	EYGA091201DF
	Thickness	70 μm	50 μm	30 μm	26 μm

\* Please contact us for other lamination type product.

\*\* Withstanding Voltages are for reference, not guaranteed.

Design and specifications are each subject to change without notice. Ask factory for the current technical specifications before purchase and/or use.

Should a safety concern arise regarding this product, please be sure to contact us immediately.

## Lamination type/Composition example

### ● High heat resistance series ( PGS 100, 70, 50, 40, 25, 17, 10 μm)

Type	High heat resistance type		
	A-V type	A-RV type	
Front face	–	High heat resistance and insulation type 13 μm	
Rear face	High heat resistance and insulation adhesion type 18 μm	High heat resistance and insulation adhesion type 18 μm	
Structure			
Features	<ul style="list-style-type: none"> <li>· With high heat resistance and insulation tape on one side</li> <li>· Withstanding Voltage Adhesive tape : 2 kV</li> </ul>	<ul style="list-style-type: none"> <li>· With high heat resistance and insulation tape on both side</li> <li>· Withstanding Voltage PEEK tape : 2 kV</li> <li>· Adhesive tape : 2 kV</li> </ul>	
Withstand temperature	150 °C	150 °C	
Standard Size	90 × 115 mm	90 × 115 mm	
Maximum size	115 × 180 mm	115 × 180 mm	
100 μm	Part No.	EYGA091210V	EYGA091210RV
	Thickness	118 μm	131 μm
70 μm	Part No.	EYGA091207V	EYGA091207RV
	Thickness	88 μm	101 μm
50 μm	Part No.	EYGA091205V	EYGA091205RV
	Thickness	68 μm	81 μm
40 μm	Part No.	EYGA091204V	EYGA091204RV
	Thickness	58 μm	71 μm
25 μm	Part No.	EYGA091203V	EYGA091203RV
	Thickness	43 μm	56 μm
17 μm	Part No.	EYGA091202V	EYGA091202RV
	Thickness	35 μm	48 μm
10 μm	Part No.	EYGA091201V	EYGA091201RV
	Thickness	28 μm	41 μm

\* Please contact us for other lamination type product.

\*\* Withstanding Voltages are for reference, not guaranteed.

### ● Standard series (SSM)

Type	E-6 type	E-8 type	E-9 type	
Elastomer thickness	1.0 mm	2.0 mm	3.0 mm	
Structure				
Features	<ul style="list-style-type: none"> <li>· Soft and low thermal resistance (Elastomer)</li> <li>· Low repulsion</li> <li>· Withstanding Voltage : 1.7 kV</li> </ul>	<ul style="list-style-type: none"> <li>· Soft and low thermal resistance (Elastomer)</li> <li>· Low repulsion</li> <li>· Withstanding Voltage : 1.7 kV</li> </ul>	<ul style="list-style-type: none"> <li>· Soft and low thermal resistance (Elastomer)</li> <li>· Low repulsion</li> <li>· Withstanding Voltage : 1.7 kV</li> </ul>	
Withstand temperature	100 °C	100 °C	100 °C	
Standard Size	90 × 115 mm	90 × 115 mm	90 × 115 mm	
70 μm	Part No.	EYGE0912XB6D	EYGE0912XB8D	EYGE0912XB9D
	Thickness	1.09 mm	2.09 mm	3.09 mm
25 μm	Part No.	EYGE0912XD6D	EYGE0912XD8D	EYGE0912XD9D
	Thickness	1.05 mm	2.05 mm	3.05 mm



## Minimum order

Item	Type	Part No.	Size	Minimum order
PGS Graphite Sheet Only	S type 100 μm	EYGS091210	90×115 mm	20
		EYGS121810	115×180 mm	10
		EYGS182310	180×230 mm	10
	S type 70 μm	EYGS091207	90×115 mm	20
		EYGS121807	115×180 mm	10
		EYGS182307	180×230 mm	10
	S type 50 μm	EYGS091205	90×115 mm	20
		EYGS121805	115×180 mm	10
		EYGS182305	180×230 mm	10
	S type 40 μm	EYGS091204	90×115 mm	20
		EYGS121804	115×180 mm	10
		EYGS182304	180×230 mm	10
	S type 25 μm	EYGS091203	90×115 mm	20
		EYGS121803	115×180 mm	10
		EYGS182303	180×230 mm	10
PGS 70, 25, 17 μm Adhesive Type [Standard series]	A-A type 70 μm	EYGA091207A	90×115 mm	20
		EYGA121807A	115×180 mm	10
	A-A type 25 μm	EYGA091203A	90×115 mm	20
		EYGA121803A	115×180 mm	10
	A-A type 17 μm	EYGA091202A	90×115 mm	20
		EYGA121802A	115×180 mm	10
	A-M type 70 μm	EYGA091207M	90×115 mm	20
		EYGA121807M	115×180 mm	10
	A-M type 25 μm	EYGA091203M	90×115 mm	20
		EYGA121803M	115×180 mm	10
	A-M type 17 μm	EYGA091202M	90×115 mm	20
		EYGA121802M	115×180 mm	10
PGS 70, 25, 17 μm Laminated Type (Insulation & Adhesive) [Standard series]	A-PA type 70 μm	EYGA091207PA	90×115 mm	20
		EYGA121807PA	115×180 mm	10
	A-PA type 25 μm	EYGA091203PA	90×115 mm	20
		EYGA121803PA	115×180 mm	10
	A-PA type 17 μm	EYGA091202PA	90×115 mm	20
		EYGA121802PA	115×180 mm	10
	A-PM type 70 μm	EYGA091207PM	90×115 mm	20
		EYGA121807PM	115×180 mm	10
	A-PM type 25 μm	EYGA091203PM	90×115 mm	20
		EYGA121803PM	115×180 mm	10
	A-PM type 17 μm	EYGA091202PM	90×115 mm	20
		EYGA121802PM	115×180 mm	10
	A-DM type 70 μm	EYGA091207DM	90×115 mm	20
		EYGA121807DM	115×180 mm	10
	A-DM type 25 μm	EYGA091203DM	90×115 mm	20
		EYGA121803DM	115×180 mm	10
	A-DM type 17 μm	EYGA091202DM	90×115 mm	20
		EYGA121802DM	115×180 mm	10

\* Only S type supports 180×230 mm size.

(PGS thickness of 17 μm, 10μm does not support as single item)

\*\* PGS of 10 μm, 40 μm, 50 μm type is also possible to be made as lamination type.

\*\*\* The above-listed part number is sample part number for testing.

\*\*\*\* Please contact us about your request of custom part number which will be arranged separately.

\*\*\*\*\* Please contact us if quantity is below Minimum Order Quantity.

## Minimum order

Item	Type	Part No.	Size	Minimum order
PGS 70, 25, 17 μm [High heat resistance type]	A-V type 70 μm	EYGA091207V	90×115 mm	20
		EYGA121807V	115×180 mm	10
	A-V type 25 μm	EYGA091203V	90×115 mm	20
		EYGA121803V	115×180 mm	10
	A-V type 17 μm	EYGA091202V	90×115 mm	20
		EYGA121802V	115×180 mm	10
	A-RV type 70 μm	EYGA091207RV	90×115 mm	20
		EYGA121807RV	115×180 mm	10
	A-RV type 25 μm	EYGA091203RV	90×115 mm	20
		EYGA121803RV	115×180 mm	10
	A-RV type 17 μm	EYGA091202RV	90×115 mm	20
		EYGA121802RV	115×180 mm	10
SSM Elastomer 3.0, 2.0, 1.0 mm PGS 70, 25, 17 μm	E-9 type Elastomer 3.0 mm, PGS 70 μm	EYGE0912XD9D	90×115 mm	5
	E-9 type Elastomer 3.0 mm, PGS 25 μm	EYGE0912XB9D	90×115 mm	5
	E-8 type Elastomer 2.0 mm, PGS 70 μm	EYGE0912XD8D	90×115 mm	5
	E-8 type Elastomer 2.0 mm, PGS 25 μm	EYGE0912XB8D	90×115 mm	5
	E-6 type Elastomer 1.0 mm, PGS 70 μm	EYGE0912XD6D	90×115 mm	5
	E-6 type Elastomer 1.0 mm, PGS 25 μm	EYGE0912XB6D	90×115 mm	5

\* Only S type supports 180×230 mm size.

(PGS thickness of 17 μm, 10μm does not support as single item)

\*\* PGS of 10 μm, 40 μm, 50 μm type is also possible to be made as lamination type.

\*\*\* The above-listed part number is sample part number for testing.

\*\*\*\* Please contact us about your request of custom part number which will be arranged separately.

\*\*\*\*\* Please contact us if quantity is below Minimum Order Quantity.

## “PGS” (Pyrolytic Graphite Sheet) Heat sink sheet

### Handling Precautions

#### ⚠ Safety Precautions

- When using our products, no matter what sort of equipment they might be used for, be sure to make a written agreement on the specifications with us in advance. The design and specifications in this catalog are subject to change without prior notice.
- Do not use the products beyond the specifications described in this catalog.
- This catalog explains the quality and performance of the products as individual components. Before use, check and evaluate their operations when installed in your products.
- Install the following systems for a failsafe design to ensure safety if these products are to be used in equipment where a defect in these products may cause the loss of human life or other significant damage, such as damage to vehicles (automobile, train, vessel), traffic lights, medical equipment, aerospace equipment, electric heating appliances, combustion/gas equipment, rotating equipment, and disaster/crime prevention equipment.
- \* Systems equipped with a protection circuit and a protection device
- \* Systems equipped with a redundant circuit or other system to prevent an unsafe status in the event of a single fault

PGS (Pyrolytic Graphite Sheet) Heat sink sheet (hereafter referred to as PGS) may result in accidents or trouble when subjected to severe conditions of electrical, environmental and /or mechanical stress beyond the specified “Rating” and specified “Conditions” found in the Specifications. Please follow the recommendations in “Safety Precautions” and “Application Notes”. Contact our engineering staff or the factory with any questions.

#### 1. ⚠ Safety Precautions

- 1.1 The PGS shall be used within the specified operating temperature range.
- 1.2 The PGS is soft, do not rub or touch it with rough materials to avoid scratching it.
- 1.3 Lines or folds in the PGS may affect thermal conductivity.
- 1.4 The PGS shall not be used with acid.  
The PGS shall not be used in contact with a soldering iron at 400 °C or more
- 1.5 The PGS shall not be exposed to salt water or direct sunlight during use. The PGS shall not be used in corrosive gases (hydrogen sulfide, sulfurous acid, chlorine, ammonia etc.).
- 1.6 Our PGS has been developed for general industry applications. Prior to using the PGS for special applications such as medical, work please contact our engineering staff or the factory.
- 1.7 Never touch a PGS during use because it may be extremely hot.
- 1.8 Since SSM Elastomer resin is soft, please do not store the parts under a load.
- 1.9 Please do not use the parts in the condition of jamming by contaminants such as metals in SSM Elastomer side.

#### 2. Application notes

- 2.1 Use protective materials when handling and/or applying the PGS, do not use items with sharp edges as they might tear or puncture the PGS.
- 2.2 The PGS does not work properly if overheated.
- 2.3 Thermal conductivity is dependant on the way it is used.  
Test the adaptability of PGS to your application before use.
- 2.4 The PGS has conductivity.  
If required, the PGS should be provided insulation.
- 2.5 Long term storage
  - The PGS shall not be stored under severe conditions of salt water, direct sunlight or corrosive gases (hydrogen sulfide, sulfurous acid, chlorine, ammonia etc.).
  - The PGS shall not be stored near acid.
  - Please store SSM packed at room temperature and humidity while not in use.
- 2.6 Once applying to the adherent which has dents, SSM Elastomer resin keeps its shape so it cannot be re-applied to different portion.

#### <Package markings>

Package markings include the product number, quantity, and country of origin.  
In principle, the country of origin should be indicated in English.

## “NASBIS” Insulating Sheet

Type: **EYGY/EYGN**

“NASBIS” is a heat insulating sheet, which is composed of silica aerogel and fiber sheet, created through impregnation process. Pore size of silica aerogel is 10 to 60nm, which means it has smaller space than the mean free path of the air, 68nm. Air molecules do not collide against each other inside the pores, and thus the component shows excellent heat insulation performance.



Furthermore, combining NASBIS and PGS Graphite Sheet enables controlling the direction of heat. Composite type provides greater heat insulating performance.

### Features

- Low thermal conductivity : 0.020 W/m · K typ.
- Created thin-film sheet ; Thickness : 100 μm to 1000 μm
- Various proposals are available when combined with PGS Graphite sheet
- RoHS compliant

### Recommended applications

- Smartphone, Wearable equipment, Digital Still Camera, Notebook PCs, Tablet PCs

### Explanation of Part Numbers

- NASBIS Pouch Type (EYGY\*\*\*\*\*S)

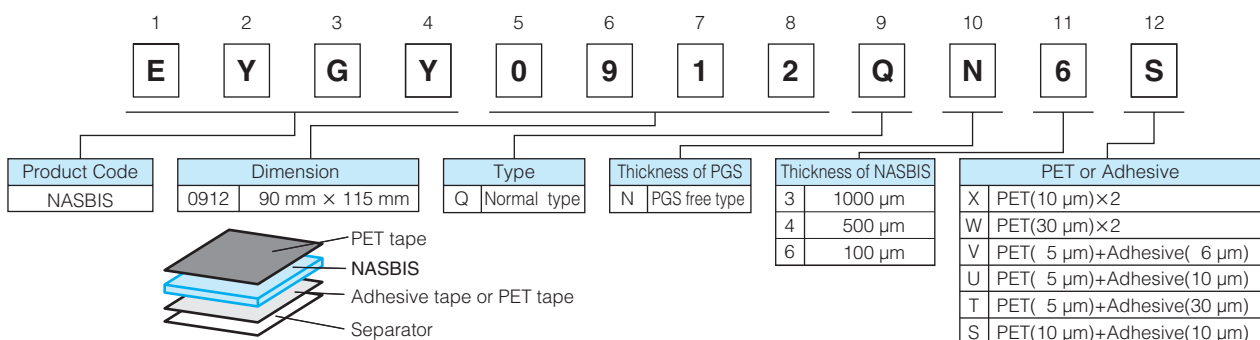

\* Please consult the other configurations separately.

- NASBIS and PGS Composit Type (EYGN\*\*\*\*\*S)

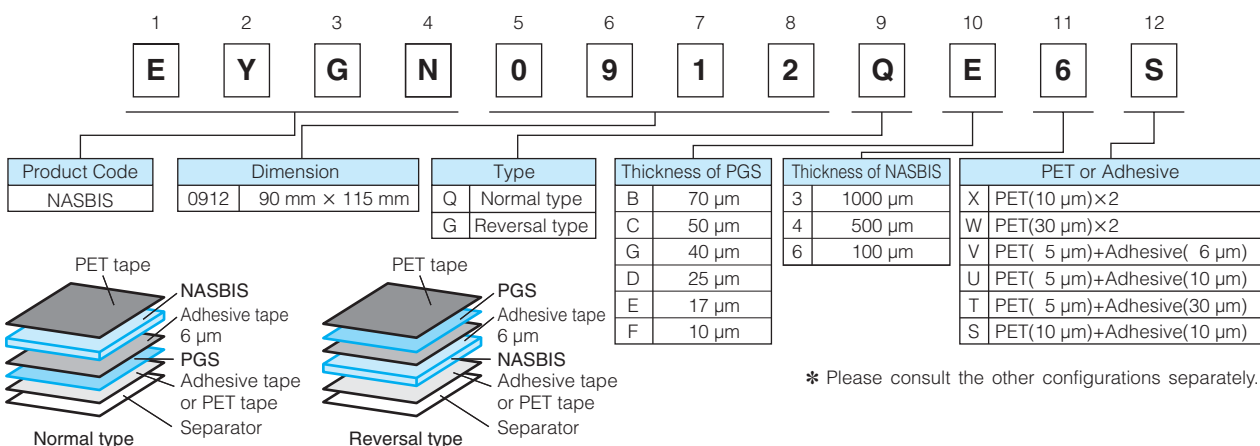

\* Please consult the other configurations separately.

## Characteristics of NASBIS





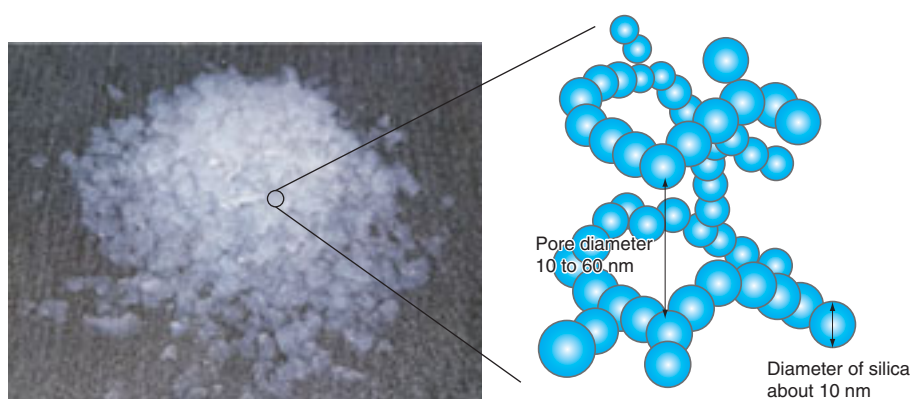







Thickness	100 μm	500 μm	1000 μm
Thermal conductivity (W/(m·K))	0.018 to 0.026	0.018 to 0.026	0.018 to 0.026
Operating temperature limit (°C)	-20 to 100	-20 to 100	-20 to 100
Size / Laminate pouch (mm)	90 × 115	90 × 115	90 × 115
Heatproof temperature(°C)	100	100	100

## Appearance of silica aerogel and its nanostructure

















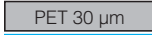



## Composition example

### ● NASBIS Pouch Type

Type		Y - X type	Y - W type	Y - T type	Y - S type
Structure		  	  	  	  
Heatproof temperature		100 °C	100 °C	100 °C	100 °C
100 μm	Standard Part No.	EYGY0912QN6X	EYGY0912QN6W	EYGY0912QN6T	EYGY0912QN6S
	Thickness	120 μm	160 μm	135 μm	120 μm
500 μm	Standard Part No.	EYGY0912QN4X	EYGY0912QN4W	EYGY0912QN4T	EYGY0912QN4S
	Thickness	520 μm	560 μm	535 μm	520 μm
1000 μm	Standard Part No.	EYGY0912QN3X	EYGY0912QN3W	EYGY0912QN3T	EYGY0912QN3S
	Thickness	1020 μm	1060 μm	1035 μm	1020 μm





















### ● NASBIS and PGS Composit Type

Normal type

Type		N - X type	N - W type	N - T type	N - S type
Structure		    	    	    	    
Heatproof temperature		100 °C	100 °C	100 °C	100 °C
100 μm	Standard Part No.	EYGN0912Q□6X	EYGN0912Q□6W	EYGN0912Q□6T	EYGN0912Q□6S
500 μm	Standard Part No.	EYGN0912Q□4X	EYGN0912Q□4W	EYGN0912Q□4T	EYGN0912Q□4S
1000 μm	Standard Part No.	EYGN0912Q□3X	EYGN0912Q□3W	EYGN0912Q□3T	EYGN0912Q□3S

### ● NASBIS and PGS Composit Type

Reversal type

Type		N - X type	N - W type	N - T type	N - S type
Structure		    	    	    	    
Heatproof temperature		100 °C	100 °C	100 °C	100 °C
100 μm	Standard Part No.	EYGN0912G□6X	EYGN0912G□6W	EYGN0912G□6T	EYGN0912G□6S
500 μm	Standard Part No.	EYGN0912G□4X	EYGN0912G□4W	EYGN0912G□4T	EYGN0912G□4S
1000 μm	Standard Part No.	EYGN0912G□3X	EYGN0912G□3W	EYGN0912G□3T	EYGN0912G□3S

■ Minimum order 10 pcs.

## “NASBIS” (NAno Silica Baloon InSulator) Insulating Sheet

### Handling Precautions

#### ⚠ Safety Precautions

- When using our products, no matter what sort of equipment they might be used for, be sure to make a written agreement on the specifications with us in advance. The design and specifications in this catalog are subject to change without prior notice.
- Do not use the products beyond the specifications described in this catalog.
- This catalog explains the quality and performance of the products as individual components. Before use, check and evaluate their operations when installed in your products.
- Install the following systems for a failsafe design to ensure safety if these products are to be used in equipment where a defect in these products may cause the loss of human life or other significant damage, such as damage to vehicles (automobile, train, vessel), traffic lights, medical equipment, aerospace equipment, electric heating appliances, combustion/gas equipment, rotating equipment, and disaster/crime prevention equipment.
- \* Systems equipped with a protection circuit and a protection device
- \* Systems equipped with a redundant circuit or other system to prevent an unsafe status in the event of a single fault

Our products may result in accidents or trouble when subjected to severe conditions of electrical, environmental and /or mechanical stress beyond the specified “Rating” and specified “Conditions” found in the Specifications. Please follow the recommendations in “Safety Precautions” and “Application Notes”. Contact our engineering staff or the factory with any questions.

#### 1. ⚠ Safety Precautions

- 1.1 Our products shall be used within the specified operating temperature range.
- 1.2 Our products are destroyed easily, so don't scratch or rub with hard materials or touch on laminate surfaces. Please note about the damage due to use the sharp-edged tool (metal tweezers) when you use our products.
- 1.3 Please do not strongly bent or cut.
- 1.4 Lines or folds in our products may affect thermal conductivity.
- 1.5 Our products shall not be used with acid, alkali.  
Our products shall not be used in contact with a soldering iron at 400 °C or more
- 1.6 Our products shall not be exposed to salt water or direct sunlight during use. Our products shall not be used in corrosive gases (hydrogen sulfide, sulfurous acid, chlorine, ammonia etc.).
- 1.7 Our products has been developed for general industry applications. Prior to using our products for special applications such as medical, work please contact our engineering staff or the factory.
- 1.8 Never touch our products during use because it may be extremely hot.
- 1.9 Please do not store the parts under a load.
- 1.10 Please do not use the parts at the status of hard foreign materials stuck such as metals.

#### 2. Application notes

- 2.1 Use protective materials when handling and/or applying our products, do not use items with sharp edges as they might tear or puncture our products
- 2.2 Our products does not work properly if overheated.
- 2.3 Thermal conductivity is dependant on the way it is used.  
Test the adaptability of our products to your application before use.
- 2.4 Long term storage
  - Please stored at a temperature of between 80 degrees -20 degrees.
  - Our products shall not be stored under severe conditions of salt water, direct sunlight or corrosive gases (hydrogen sulfide, sulfurous acid, chlorine, ammonia etc.).
  - Our products shall not be stored near acid, alkali.

#### <Package markings>

Package markings include the product number, quantity, and country of origin. In principle, the country of origin should be indicated in English.

## “Graphite-PAD” high thermal conductivity in z-direction

Type: **EYGT**

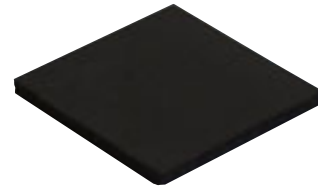

Graphite-PAD is a thermal interface material (TIM) that compatibly obtained excellent thermal conductivity in thickness direction (Z-axis direction) and high flexibility (deformable with a low load). The properties are greater than that of existing TIMs. The product is created by filling PGS Graphite Sheet into silicon resin.

### Features

- High thermal conductivity : 13 W/m · K
- Excellent compressibility : 50 % (t=2 mm, Pressure 300 kPa)
- Thermal resistance: fit into uneven parts and provide excellent thermal resistance with a low load
- High reliability : correspond to -40 to 150 °C and maintains long-term reliability
- Thickness range : 0.5/1.0/1.5/2.0/2.5/3.0 mm
- RoHS compliant

### Recommended applications

Cooling of heat generating components, such as electronic devices, semiconductor memory device, etc.

- General-purpose inverter, medical equipment, and DSC
- Car-mounted camera, motor control unit, automotive lighting (LED), car navigation, luminous source of laser HUD
- Base station, IGBT module

### Explanation of Part Numbers

- Graphite-PAD (EYGT\*\*\*\*\*A)

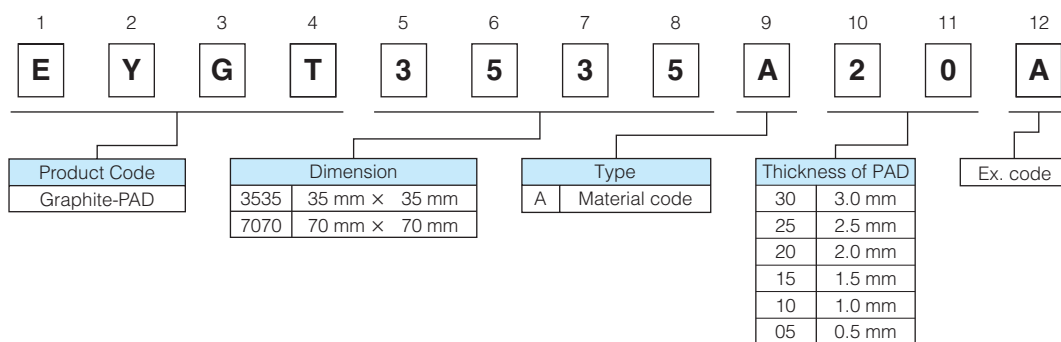

\* Please confirm other condition separately.



### Typical characteristics

Items	Test equipment/method	Condition	Data				
Thickness (mm)			0.5	1.0	1.5	2.0	3.0
Thermal resistance (K·cm <sup>2</sup> /W)	TIM Tester	100 kPa	0.96	1.34	1.56	1.93	2.36
Compressibility (%)	TIM Tester	100 kPa (50 °C)	5.78	10.29	17.46	17.8	17.9
Thermal conductivity of Graphite-PAD with a unit (W/m·K) (including contact resistance)	TIM Tester	100 kPa	5.08	7.02	7.80	8.60	10.10
Thermal conductivity of the Graphite-PAD (W/m·K)	(ASTM D5470)	50 kPa	13				
Hardness	(ASTM D2240)	TYPE E	25				
Adhesive			Adhesive on both faces				
Volume resistivity (Ω·cm)	(ASTM D257)		40×10 <sup>5</sup>				
Operating temperature range (°C)			-40 to 150				
Siloxane		Σ (D4-D10)	≤ 70 ppm				

### Structure

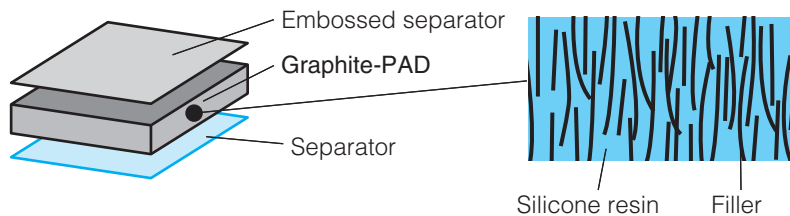

### Thermal resistance and Compressibility

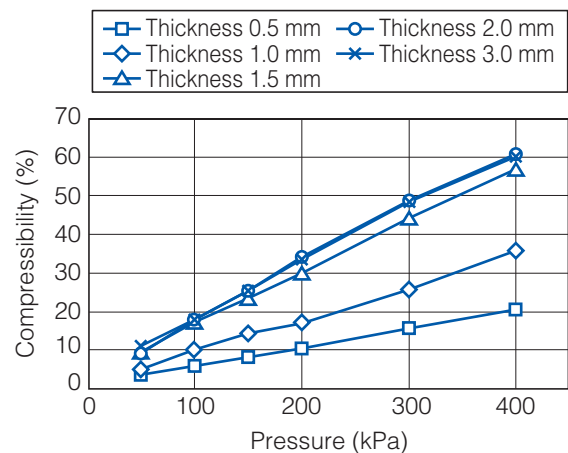
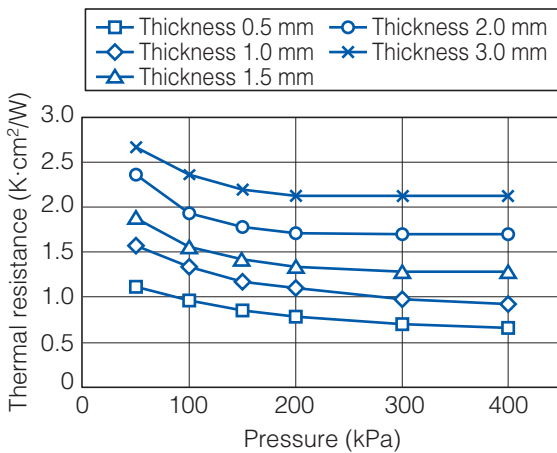

### Composition example

Structure			
		Operating temperature range	
Standard dimension		35 × 35 mm	70 × 70 mm
0.5 mm	Standard Part No.	EYGT3535A05A	EYGT7070A05A
	Thickness	0.5 mm	0.5 mm
1.0 mm	Standard Part No.	EYGT3535A10A	EYGT7070A10A
	Thickness	1.0 mm	1.0 mm
1.5 mm	Standard Part No.	EYGT3535A15A	EYGT7070A15A
	Thickness	1.5 mm	1.5 mm
2.0 mm	Standard Part No.	EYGT3535A20A	EYGT7070A20A
	Thickness	2.0 mm	2.0 mm
2.5 mm	Standard Part No.	EYGT3535A25A	EYGT7070A25A
	Thickness	2.5 mm	2.5 mm
3.0 mm	Standard Part No.	EYGT3535A30A	EYGT7070A30A
	Thickness	3.0 mm	3.0 mm

\* Part numbers listed above are all standard samples for your consideration.

\*\* Contact us for custom-made samples.

We can make samples in various forms and/or dimensions other than standard samples.

## “Graphite-PAD” high thermal conductivity in z-direction

### Handling Precautions

#### ⚠ Safety Precautions

- When using our products, no matter what sort of equipment they might be used for, be sure to make a written agreement on the specifications with us in advance. The design and specifications in this catalog are subject to change without prior notice.
- Do not use the products beyond the specifications described in this catalog.
- This catalog explains the quality and performance of the products as individual components. Before use, check and evaluate their operations when installed in your products.
- Install the following systems for a failsafe design to ensure safety if these products are to be used in equipment where a defect in these products may cause the loss of human life or other significant damage, such as damage to vehicles (automobile, train, vessel), traffic lights, medical equipment, aerospace equipment, electric heating appliances, combustion/gas equipment, rotating equipment, and disaster/crime prevention equipment.
- \* Systems equipped with a protection circuit and a protection device
- \* Systems equipped with a redundant circuit or other system to prevent an unsafe status in the event of a single fault

Graphite-PAD may result in accidents or trouble when subjected to severe conditions of electrical, environmental and /or mechanical stress beyond the specified “Rating” and specified “Conditions” found in the Specifications. Please follow the recommendations in “Safety Precautions” and “Application Notes”. Contact our engineering staff or the factory with any questions.

#### 1. ⚠ Safety Precautions

- 1.1 The Graphite-PAD shall be used within the specified operating temperature range.
- 1.2 The Graphite-PAD is soft, do not rub or touch it with rough materials to avoid scratching it.
- 1.3 Lines or folds in the Graphite-PAD may affect thermal conductivity.
- 1.4 The Graphite-PAD shall not be used with acid.  
The Graphite-PAD shall not be used in contact with a soldering iron at 150 °C or more.
- 1.5 The Graphite-PAD shall not be exposed to salt water or direct sunlight during use. The Graphite-PAD shall not be used in corrosive gases (hydrogen sulfide, sulfurous acid, chlorine, ammonia etc.).
- 1.6 Our Graphite-PAD has been developed for general industry applications. Prior to using the Graphite-PAD for special applications such as medical, work please contact our engineering staff or the factory.
- 1.7 Never touch a Graphite-PAD during use because it may be extremely hot.

#### 2. Application notes

- 2.1 Do not use items with sharp edges as they might tear or puncture the Graphite-PAD.
- 2.2 The Graphite-PAD does not work properly if overheated.
- 2.3 Thermal conductivity is dependant on the way it is used.  
Test the adaptability of Graphite-PAD to your application before use.
- 2.4 The Graphite-PAD has conductivity. Use the product at a position/place where you do not need any insulation.
- 2.5 Long term storage
  - The Graphite-PAD shall not be stored under severe conditions of salt water, direct sunlight or corrosive gases (hydrogen sulfide sulfurous acid, chlorine, ammonia etc.).
  - The Graphite-PAD shall not be stored near acid.

#### <Package markings>

Package markings include the product number, quantity, and country of origin. In principle, the country of origin should be indicated in English.

### “Soft-PGS (Compressible Type)” PGS with low thermal resistance

Type: **EYGS**



Soft-PGS (Compressible Type) is a graphite sheet that is dedicated for use as a thermal interface material.

The Soft-PGS (Compressible Type) has very high compressibility compared to standard PGS, which enables reducing the thermal resistance by following gap, warpage, and distortion of targets/substrates.

Excellent heat resistance and reliability of the Soft-PGS help obtaining longer service life and higher performance of various components, such as power modules.

The Soft-PGS (Compressible Type) is cost-saving, because it may allow you to reduce your existing processes. Unlike grease, there is no necessity for printing process, since it is a sheet-type product.

There are no problems that are found in grease and phase change materials in the Soft-PGS, which makes it excellent TIM.

#### Features

- Thermal resistance : 0.2K·cm<sup>2</sup>/W (600 kPa)  
To draw a good thermal resistance from sheet, pressure the Soft-PGS. A close adherence would make the product fit into the uneven part and enhance the performance.
- Thermal conductivity : X-Y direction 400W/m·K, Z direction (20W/m·K)
- Compressibility : 40 % (600k Pa)
- High and long term reliability : operating temperature range -55 to 400 °C
- RoHs compliant



After pressure

#### Recommended applications

For cooling/heat transfer of electronic devices that generates heat, such as power modules.

- Inverters and converters
- Car-mounted camera, motor control unit, automotive LED, luminous source of laser HUD, medical equipment
- Base station, Server

Install in IGBT module

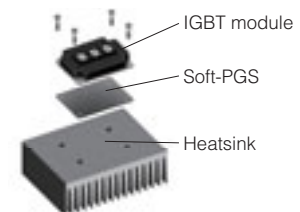

#### Explanation of Part Numbers

- Soft-PGS(EYGS\*\*\*\*ZL\*\*)

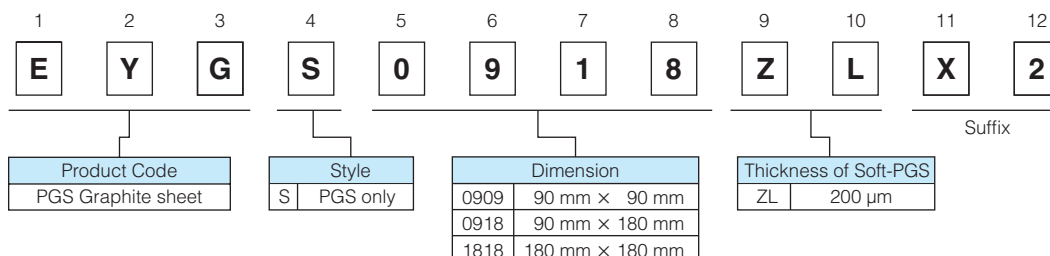

\* Please contact us for custom-made products.

### Typical characteristics

Items	Test method	Condition	Data
Thickness ( $\mu\text{m}$ )			200
Thermal resistance ( $\text{K}\cdot\text{cm}^2/\text{W}$ )	TIM Tester	600 kPa	0.2
Compressibility (%)	TIM Tester	600 kPa	40
Thermal conductivity ( $\text{W}/\text{m}\cdot\text{K}$ )	Laser PIT	X-Y	400 (300 to 600)
		Z	TBD
Operating temperature range ( $^{\circ}\text{C}$ )			-55 to 400

Typical values, not guaranteed.

### Thermal resistance and compressibility

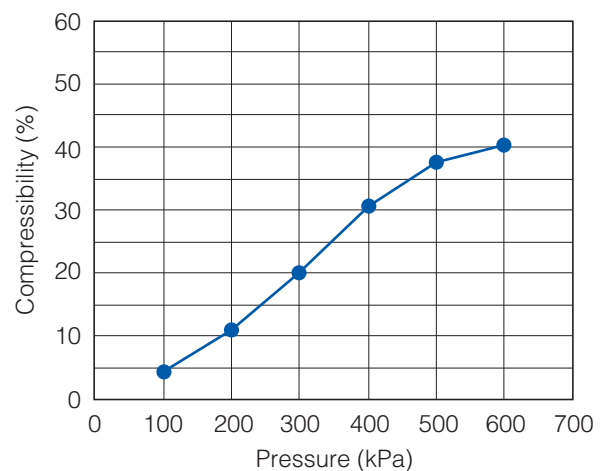
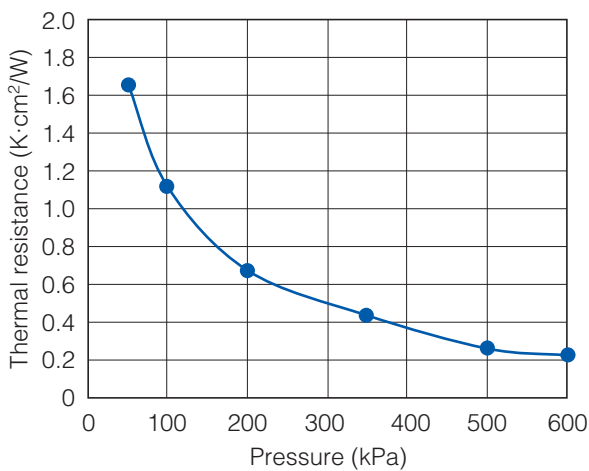

### Lamination type/Composition example

- Soft-PGS (Compressible Type) standard form

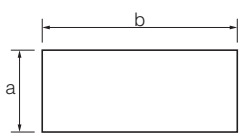
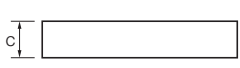
Type		Sheet only
		S Type
Process for IGBT mounting		-
Structure	Front	
	Side	
Operating Temperature Range		-55 to 400 $^{\circ}\text{C}$
Thickness: c		200 $\mu\text{m}$
Standard Part No.	90 × 90 mm	EYGS0909ZLX2
	90 × 180 mm	EYGS0918ZLX2
	180 × 180 mm	EYGS1818ZLX2

\* Part numbers listed above are all standard samples for your consideration.

\*\* Contact us for custom-made samples.

We can make samples in various forms and/or dimensions other than standard samples.

● PGS in IGBT forms

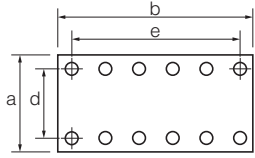
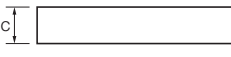
Type		Sheet only
		S Type
Process for IGBT mounting		Lamination
Structure	Front	 <p>* This shape is an example, please contact us for detailed shape of each part no.</p>
	Side	
Operating Temperature Range		-55 to 400 °C
Thickness: c		200 μm

No.	Standard Part No.	a : Lateral size (mm)	b : Longitudinal size (mm)	Hole number	Hole diameter (φmm)	d : Lateral hole pitch (mm)	e : Longitudinal hole pitch (mm)
1	EYGS1431ZLAA	140	308	12	6	126	290
2	EYGS0925ZLWA	85	246	14	6	73	234
3	EYGS1419ZLWB	136	186	8	7.5	124	171
4	EYGS0917ZLWC	85	168	10	6	73	156
5	EYGS1316ZLAC	125	163	8	6.1	110	150
6	EYGS1216ZLWD	120	160	8	6	110	150
7	EYGS1116ZLMA	108.8	158	8	6	92.75	144
8	EYGS1315ZLGA	129.5	150	8	7	118.5	137.5
9	EYGS1314ZLWE	126	136	6	7.5	114	124
10	EYGS1014ZLAD	97.8	138	4	6.8	86	127
11	EYGS0714ZLAE	70	138	4	5.7	57	128
12	EYGS0714ZLAF	69	136	4	7.2	57	124
13	EYGS1113ZLMB	106	132	4	5.7	95	121
14	EYGS1313ZLGB	128	128	4	6.7	110	110
15	EYGS0713ZLAG	66	126	4	5.7	50	116
16	EYGS0813ZLMD	71	123	2	4.7	Center	116
17	EYGS1212ZLGC	120	120	4	5.7	110	110
18	EYGS0912ZLGD	88	120	4	5.7	78	110
19	EYGS0612ZLWF	60	120	4	5.7	50	110
20	EYGS0512ZLGE	53	118	2	5.7	Center	106
21	EYGS0811ZLGH	80	113	4	5.7	70	103
22	EYGS0811ZLWG	78	108	4	6.7	62	93
23	EYGS0611ZLWH	60	106	4	6.7	48	93
24	EYGS0411ZLWJ	43	105.5	2	5.7	Center	93
25	EYGS0610ZLAH	59.4	104.4	4	6.7	48	93
26	EYGS0410ZLAJ	43	102.8	2	5.7	Center	93
27	EYGS1010ZLME	98	98	4	6.7	87	87

No.	Standard Part No.	a : Lateral size (mm)	b : Longitudinal size (mm)	Hole number	Hole diameter (φmm)	d : Lateral hole pitch (mm)	e : Longitudinal hole pitch (mm)
28	EYGS0409ZLGJ	44	93	2	6.7	Center	80
29	EYGS0509ZLGK	46	92	2	6.7	Center	80
30	EYGS0309ZLMF	32	92	2	6.7	Center	80
31	EYGS0409ZLMG	41	88	2	5.7	Center	80
32	EYGS0309ZLAK	29.5	89.5	2	6.6	Center	80
33	EYGS0509ZLMH	51	86	2	4.7	–	80
34	EYGS0508ZLMJ	46.2	83	2	4.7	–	77
35	EYGS0608ZLMK	55	78	2	4.5	Center	40
36	EYGS0607ZLGL	58	69.7	4	5.7	50	62
37	EYGS0507ZLML	45.3	66	2	4.7	–	60
38	EYGS0407ZLAL	40	65.5	1	7.7	Center	Center
39	EYGS0506ZLMM	48	55	1	4.5	Center	Center
40	EYGS0404ZLMP	36	38	1	4.5	Center	Center
41	EYGS1018ZLSA	104.5	182.5	8	7	93	171
42	EYGS1516ZLSB	148	158	8	5	137	150
43	EYGS1116ZLSC	112	158	8	5	101	150
44	EYGS0715ZLSD	67	153	4	5.6	57	143
45	EYGS0613ZLSE	61	127.5	4	5.6	50	116
46	EYGS0612ZLSF	63.3	124	4	5.6	50	110
47	EYGS0612ZLSG	61.5	124	4	5.6	50	110
48	EYGS1012ZLSH	104.5	121	4	6.7	93	109.5
49	EYGS0410ZLSJ	43	103	2	5.7	Center	93
50	EYGS0609ZLSK	61.5	91	4	5.6	50	77
51	EYGS0606ZLSL	58	61.5	2	5.6	44	50
52	EYGS0305ZLSM	27	51	1	4.6	Center	Center
53	EYGS0204ZLSN	24	36.5	1	4.6	Center	Center
54	EYGS0303ZLSP	29	32	1	4.5	Center	Center
55	EYGS0911ZLDA	92	109	4	6	78	93
56	EYGS1014ZLDB	98	138	4	6.7	86	127

## “Soft-PGS (Compressible Type)” PGS with low thermal resistance

### Handling Precautions

#### ⚠ Safety Precautions

- When using our products, no matter what sort of equipment they might be used for, be sure to make a written agreement on the specifications with us in advance. The design and specifications in this catalog are subject to change without prior notice.
- Do not use the products beyond the specifications described in this catalog.
- This catalog explains the quality and performance of the products as individual components. Before use, check and evaluate their operations when installed in your products.
- Install the following systems for a failsafe design to ensure safety if these products are to be used in equipment where a defect in these products may cause the loss of human life or other significant damage, such as damage to vehicles (automobile, train, vessel), traffic lights, medical equipment, aerospace equipment, electric heating appliances, combustion/gas equipment, rotating equipment, and disaster/crime prevention equipment.
- \* Systems equipped with a protection circuit and a protection device
- \* Systems equipped with a redundant circuit or other system to prevent an unsafe status in the event of a single fault

Soft-PGS (Compressible Type) may result in accidents or trouble when subjected to severe conditions of electrical, environmental and /or mechanical stress beyond the specified “Rating” and specified “Conditions” found in the Specifications. Please follow the recommendations in “Safety Precautions” and “Application Notes”. Contact our engineering staff or the factory with any questions.

#### 1. ⚠ Safety Precautions

- 1.1 The Soft-PGS (Compressible Type) shall be used within the specified operating temperature range.
- 1.2 The Soft-PGS (Compressible Type) is soft and liable to be scratched, do not rub or touch it with rough materials to avoid scratching it.
- 1.3 Lines or folds in the Soft-PGS (Compressible Type) may affect thermal conductivity.
- 1.4 The Soft-PGS (Compressible Type) shall not be used with acid.  
The Soft-PGS (Compressible Type) shall not be used in contact with a soldering iron at 400 °C or more.
- 1.5 The Soft-PGS (Compressible Type) shall not be exposed to salt water or direct sunlight during use. The Soft-PGS (Compressible Type) shall not be used in corrosive gases (hydrogen sulfide, sulfurous acid, chlorine, ammonia etc.).
- 1.6 Our Soft-PGS (Compressible Type) has been developed for general industry applications. Prior to using the Soft-PGS (Compressible Type) for special applications such as medical, work please contact our engineering staff or the factory.
- 1.7 Never touch a Soft-PGS (Compressible Type) during use because it may be extremely hot.

#### 2. Application notes

- 2.1 Do not use items with sharp edges as they might tear or puncture the Soft-PGS (Compressible Type).
- 2.2 Force applied in peeling direction can cause delamination of the Soft-PGS (Compressible Type), so give a careful consideration when designing a product.
- 2.3 The Soft-PGS (Compressible Type) does not work properly if overheated.
- 2.4 Thermal resistance and thermal conductivity is dependant on the way it is used.  
Test the adaptability of Soft-PGS (Compressible Type) to your application before use.
- 2.5 The Soft-PGS (Compressible Type) has conductivity. Use the product at a position/place where you do not need any insulation.
- 2.6 Long term storage
  - The Soft-PGS (Compressible Type) shall not be stored under severe conditions of salt water, direct sunlight or corrosive gases (hydrogen sulfide sulfurous acid, chlorine, ammonia etc.).
  - The Soft-PGS (Compressible Type) shall not be stored near acid.

#### <Package markings>

Package markings include the product number, quantity, and country of origin. In principle, the country of origin should be indicated in English.



## CAUTION AND WARNING

1. The electronic components contained in this catalog are designed and produced for use in home electric appliances, office equipment, information equipment, communications equipment, and other general purpose electronic devices.  
Before use of any of these components for equipment that requires a high degree of safety, such as medical instruments, aerospace equipment, disaster-prevention equipment, security equipment, vehicles (automobile, train, vessel), please be sure to contact our sales representative.
2. When applying one of these components for equipment requiring a high degree of safety, no matter what sort of application it might be, be sure to install a protective circuit or redundancy arrangement to enhance the safety of your equipment. In addition, please carry out the safety test on your own responsibility.
3. When using our products, no matter what sort of equipment they might be used for, be sure to make a written agreement on the specifications with us in advance.
4. Technical information contained in this catalog is intended to convey examples of typical performances and/or applications and is not intended to make any warranty with respect to the intellectual property rights or any other related rights of our company or any third parties nor grant any license under such rights.
5. In order to export products in this catalog, the exporter may be subject to the export license requirement under the Foreign Exchange and Foreign Trade Law of Japan.
6. No ozone-depleting substances (ODSs) under the Montreal Protocol are used in the manufacturing processes of Automotive & Industrial Systems Company, Panasonic Corporation.

● Please contact

● Factory

**Device Solutions Business Division**  
**Automotive & Industrial Systems Company**  
**Panasonic Corporation**  
1006 Kadoma, Kadoma City, Osaka 571-8506,  
JAPAN

The information in this catalog is valid as of December, 2016.